

# MOUNTING AND OPERATING INSTRUCTIONS



**EB 5827-2 EN**

Translation of original instructions



**Type 5827 Electric Actuator**  
Version with positioner

Firmware version 2.0



Edition September 2023

## Note on these mounting and operating instructions

These mounting and operating instructions assist you in mounting and operating the device safely. The instructions are binding for handling SAMSON devices. The images shown in these instructions are for illustration purposes only. The actual product may vary.

- For the safe and proper use of these instructions, read them carefully and keep them for later reference.
- If you have any questions about these instructions, contact SAMSON's After-sales Service ([aftersaleservice@samsongroup.com](mailto:aftersaleservice@samsongroup.com)).



Documents relating to the device, such as the mounting and operating instructions, are available on our website at [www.samsongroup.com](http://www.samsongroup.com) > **Service & Support > Downloads > Documentation.**

## Definition of signal words

### **DANGER**

*Hazardous situations which, if not avoided, will result in death or serious injury*

### **WARNING**

*Hazardous situations which, if not avoided, could result in death or serious injury*

### **NOTICE**

*Property damage message or malfunction*

### **Note**

*Additional information*

### **Tip**

*Recommended action*

<b>1</b>	<b>Safety instructions and measures</b> .....	<b>1-1</b>
1.1	Notes on possible severe personal injury .....	1-4
1.2	Notes on possible personal injury .....	1-5
1.3	Notes on possible property damage .....	1-6
1.4	Warnings on the device.....	1-7
<b>2</b>	<b>Markings on the device</b> .....	<b>2-1</b>
2.1	Nameplate .....	2-1
2.2	Device code.....	2-2
<b>3</b>	<b>Design and principle of operation</b> .....	<b>3-1</b>
3.1	Fail-safe action .....	3-2
3.2	Communication .....	3-2
3.3	Additional equipment.....	3-3
3.4	Technical data .....	3-4
3.5	Dimensions.....	3-8
<b>4</b>	<b>Shipment and on-site transport</b> .....	<b>4-1</b>
4.1	Accepting the delivered goods .....	4-1
4.2	Removing the packaging from the actuator .....	4-1
4.3	Transporting the actuator.....	4-1
4.4	Lifting the actuator .....	4-1
4.5	Storing the actuator.....	4-1
<b>5</b>	<b>Installation</b> .....	<b>5-1</b>
5.1	Installation conditions .....	5-1
5.2	Preparation for installation.....	5-1
5.3	Aligning the travel indication scale.....	5-2
5.4	Mounting the actuator .....	5-3
5.4.1	Actuator without fail-safe action .....	5-3
5.4.1.1	Force-locking attachment .....	5-3
5.4.1.2	Form-fit attachment .....	5-3
5.4.2	Actuator with fail-safe action .....	5-3
5.4.2.1	Force-locking attachment .....	5-3
5.4.2.2	Form-fit attachment .....	5-4
5.5	Installing the control valve into the pipeline .....	5-4
5.6	Electrical connection.....	5-6

## Contents

<b>6</b>	<b>Operation .....</b>	<b>6-1</b>
6.1	Device overview and operating controls .....	6-1
6.1.1	Indication with LEDs .....	6-2
6.1.2	Function switch .....	6-3
6.1.3	Direction of action switch .....	6-5
6.1.4	Actuating shaft (opened front housing cover) .....	6-6
<b>7</b>	<b>Start-up and configuration .....</b>	<b>7-1</b>
7.1	Initializing the actuator .....	7-1
7.2	Configuring the actuator .....	7-2
7.3	Adjusting the limit contacts .....	7-3
<b>8</b>	<b>Operation .....</b>	<b>8-1</b>
8.1	Positioner .....	8-1
8.2	LED blinking pattern .....	8-1
8.3	Manual override .....	8-2
8.3.1	Mechanical override .....	8-3
8.4	Operation using memory pen .....	8-4
8.4.1	Copying function .....	8-6
8.4.2	Data logging .....	8-7
8.4.3	Command mode .....	8-8
8.5	Readings in TROVIS-VIEW .....	8-8
8.5.1	Operating values .....	8-8
8.5.2	Operating states .....	8-8
8.5.3	Status messages .....	8-9
8.5.4	Statistics .....	8-10
<b>9</b>	<b>Malfunctions .....</b>	<b>9-1</b>
9.1	Error indication by LEDs .....	9-2
9.2	Emergency action .....	9-3
<b>10</b>	<b>Servicing .....</b>	<b>10-1</b>
<b>11</b>	<b>Decommissioning .....</b>	<b>11-1</b>
<b>12</b>	<b>Removal .....</b>	<b>12-1</b>
12.1	Force-locking attachment .....	12-1
12.2	Form-fit attachment .....	12-1
<b>13</b>	<b>Repairs .....</b>	<b>13-1</b>
13.1	Returning the actuator to SAMSON .....	13-1
<b>14</b>	<b>Disposal .....</b>	<b>14-1</b>

<b>15</b>	<b>Certificates</b> .....	<b>15-1</b>
15.1	Information on the UK sales region .....	15-1
<b>16</b>	<b>Annex A (Configuration and Operating Instructions)</b> .....	<b>16-1</b>
16.1	Location of switches and LEDs .....	16-1
16.1.1	LEDs .....	16-1
16.1.2	Function switch .....	16-2
16.1.3	Direction of action switch .....	16-3
16.2	Input signal .....	16-4
16.2.1	Split-range operation .....	16-4
16.3	Position feedback signal .....	16-4
16.4	Functions .....	16-5
16.4.1	Detect input signal failure .....	16-5
16.4.2	End position guiding .....	16-6
16.5	Blockage .....	16-6
16.5.1	Blocking protection .....	16-6
16.6	Travel .....	16-7
16.6.1	Limited travel range .....	16-7
16.6.2	Travel adjustment .....	16-7
16.6.3	Idle time during end position guiding .....	16-8
16.6.4	Speed .....	16-8
16.6.5	Dead band (switching range) .....	16-9
16.6.6	Characteristic .....	16-9
16.6.7	Start-up .....	16-11
16.6.8	Functions ('Service' folder) .....	16-11
16.6.8.1	Manual level .....	16-11
16.6.8.2	Functions .....	16-12
<b>17</b>	<b>Annex B</b> .....	<b>17-1</b>
17.1	Accessories .....	17-1
17.2	After-sales service .....	17-2
17.3	Configuration list and customer-specific data .....	17-3



# 1 Safety instructions and measures

## Intended use

The Type 5827 Electric Actuator is designed to operate a mounted globe valve used in heating, ventilation and air-conditioning systems as well as in process engineering and industrial energy transfer systems. The digital positioner ensures a predetermined assignment of the valve position to the input signal.

The actuator is designed to operate under exactly defined conditions (e.g. thrust, travel). Therefore, operators must ensure that the actuator is only used in operating conditions that meet the specifications used for sizing the actuator at the ordering stage. In case operators intend to use the actuator in applications or conditions other than those specified, contact SAMSON.

SAMSON does not assume any liability for damage resulting from the failure to use the device for its intended purpose or for damage caused by external forces or any other external factors.

→ Refer to the technical data for limits and fields of application as well as possible uses. See the 'Design and principle of operation' section.

## Reasonably foreseeable misuse

The actuator is not suitable for the following applications:

- Use outside the limits defined during sizing and by the technical data
- Outdoor use

Furthermore, the following activities do not comply with the intended use:

- Use of non-original spare parts
- Performing service and repair work not described

## Qualifications of operating personnel

The actuator must be mounted, started up, serviced and repaired by fully trained and qualified personnel only; the accepted industry codes and practices must be observed. According to these mounting and operating instructions, trained personnel refers to individuals who are able to judge the work they are assigned to and recognize possible hazards due to their specialized training, their knowledge and experience as well as their knowledge of the applicable standards.

## **Safety instructions and measures**

### **Personal protective equipment**

No personal protective equipment is required for the direct handling of the electric actuator. Work on the control valve may be necessary when mounting or removing the device.

- Observe the requirements for personal protective equipment specified in the valve documentation.
- Check with the plant operator for details on further protective equipment.

### **Revisions and other modifications**

Revisions, conversions or other modifications of the product are not authorized by SAMSON. They are performed at the user's own risk and may lead to safety hazards, for example. Furthermore, the product may no longer meet the requirements for its intended use.

### **Safety features**

The limit switches switch off the motor in the end positions. Upon supply voltage failure, a valve, which has an electric actuator with fail-safe action mounted on it, moves to a certain fail-safe position. The direction of the fail-safe action is specified on the nameplate of SAMSON actuators.

### **Warning against residual hazards**

To avoid personal injury or property damage, plant operators and operating personnel must prevent hazards that could be caused in the control valve by the process medium, the operating pressure, the signal pressure or by moving parts by taking appropriate precautions. Plant operators and operating personnel must observe all hazard statements, warnings and caution notes in these mounting and operating instructions, especially for installation, start-up and service work.

### **Responsibilities of the operator**

Operators are responsible for proper use and compliance with the safety regulations. Operators are obliged to provide these mounting and operating instructions to the operating personnel and to instruct them in proper operation. Furthermore, operators must ensure that operating personnel or third parties are not exposed to any danger.



### Responsibilities of operating personnel

Operating personnel must read and understand these mounting and operating instructions as well as the specified hazard statements, warnings and caution notes. Furthermore, operating personnel must be familiar with the applicable health, safety and accident prevention regulations and comply with them.

### Referenced standards, directives and regulations

Devices with a CE marking fulfill the requirements of the following Directives:

- 2014/30/EU
- 2014/35/EU
- 2011/65/EU

Devices with a UKCA marking fulfill the requirements of the following Regulations:

- SI 2016 No. 1091 (The Electromagnetic Compatibility Regulations 2016)
- SI 2016 No. 1101 (The Electrical Equipment (Safety) Regulations 2016)
- SI 2012 No. 3032 (The Restriction of the Use of Hazardous Substances in Electrical and Electronic Equipment Regulations 2012)

Devices with an EAC marking fulfill the requirements of the following Regulations:

- TR CU 004/2011
- TR CU 020/2011

The declarations of conformity and the TR CU certificate can be found in the 'Certificates' section of these mounting and operating instructions.

The Type 5827 Electric Actuator is designed for use in low-voltage installations.

➔ For wiring, maintenance and repair, observe the relevant safety regulations.

### Referenced documentation

The following documents apply in addition to these mounting and operating instructions:

- Mounting and operating instructions of the valve on which the electric actuator is mounted, e.g. for SAMSON valves:
  - ▶ EB 5861 for Type 3260 Three-way Valve
  - ▶ EB 5863 for Type 3226 Three-way Valve
  - ▶ EB 5866 for Type 3222 Globe Valve
  - ▶ EB 5868 for Type 3213 and Type 3214 Globe Valves
  - ▶ EB 8111 for Type 3321 Globe Valve
  - ▶ EB 8113 for Type 3323 Three-way Valve
  - ▶ EB 8131 for Type 3531 Globe Valve for Heat Transfer Oil
  - ▶ EB 8135 for Type 3535 Three-way Valve for Heat Transfer Oil

## 1.1 Notes on possible severe personal injury

### DANGER

#### **Risk of fatal injury due to electric shock.**

- Before connecting wiring, performing any work on the device or opening the device, disconnect the supply voltage and protect it against unintentional reconnection.
- Only use power interruption devices that can be protected against unintentional reconnection of the power supply.
- Do not remove any covers to perform adjustment work on live parts.
- Do not open the back housing cover.

The electric actuator with the housing cover closed is protected against spray water (IP54).

- Avoid jets of water.

## 1.2 Notes on possible personal injury

### **WARNING**

#### **Crush hazard arising from moving parts.**

The form-fit version of the electric actuator contains moving parts (actuator and plug stems), which can injure hands or fingers if inserted into the actuator.

- Do not insert hands or finger into the yoke while the valve is in operation.
- Disconnect the supply voltage and protect it against unintentional reconnection before performing any work on the control valve.
- Do not impede the movement of the actuator or plug stem by inserting objects into their path.

#### **Risk of personal injury due to incorrect operation, use or installation as a result of information on the actuator being illegible.**

Over time, markings, labels and nameplates on the actuator may become covered with dirt or become illegible in some other way. As a result, hazards may go unnoticed and the necessary instructions not followed. There is a risk of personal injury.

- Keep all relevant markings and inscriptions on the device in a constantly legible state.
- Immediately renew damaged, missing or incorrect nameplates or labels.

#### **Risk of injury due to a power surge.**

The serial interface of the electric actuator is not fitted with a surge protector.

- Ensure that surge protection is provided upon connecting cables.

## 1.3 Notes on possible property damage

### NOTICE

#### **Risk of damage to the electric actuator due to the supply voltage exceeding the permissible tolerances.**

The Type 5827 Electric Actuator is designed for use according to regulations for low-voltage installations.

→ Observe the permissible tolerances of the supply voltage.

#### **Risk of actuator damage due to excessively high tightening torques.**

The connection of the Type 5827 Electric Actuator must be tightened with certain torques. Excessive tightening torques lead to parts wearing out more quickly.

→ Observe the specified tightening torques.

#### **Risk of damage to the electric actuator by moving the actuator stem too far.**

The actuator stem of the electric actuator can be adjusted manually.

→ Move the actuator stem only as far as the bottom or top end position.

#### **Risk of damage to the electric actuator due to overvoltage.**

The serial interface of the electric actuator is not fitted with a surge protector.

→ Ensure that surge protection is provided upon connecting cables.

#### **Risk of actuator damage due to direct contact with steam.**

→ During mounting, make sure that the actuator cannot come into contact with a jet of steam during operation.

## 1.4 Warnings on the device

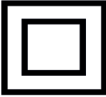
Warning symbols	Meaning	Location on the device
	<p>General warning                      → Refer to the mounting and operating instructions.</p>	<p>Actuator housing</p>
	<p>Class of protection 2, only effective when the housing cover is closed and locked                      → Refer to the mounting and operating instructions.</p>	<p>Actuator housing</p>





## 2 Markings on the device

### 2.1 Nameplate

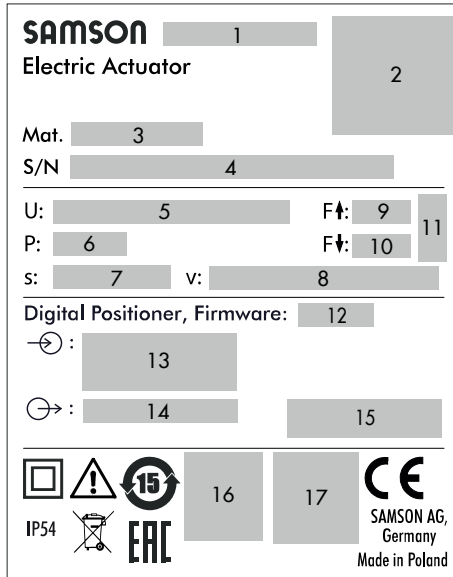
The nameplate shown was up to date at the time of publication of this document. The nameplate on the device may differ from the one shown.



- |  |  |
|--|--|
| <ul style="list-style-type: none"> <li>1 Type designation</li> <li>2 Data Matrix code</li> <li>3 Material number</li> <li>4 Serial number, date of manufacture</li> <li>5 Supply voltage; power line frequency</li> <li>6 Power consumption</li> <li>7 Rated travel</li> <li>8 Stroking speed</li> <li>9 Thrust (actuator stem retracts)</li> <li>10 Thrust (actuator stem extends)</li> </ul> | <ul style="list-style-type: none"> <li>11 Fail-safe action</li> </ul> <div style="display: flex; align-items: center; margin-top: 10px;"> <div style="text-align: center; margin-right: 10px;"> <br/>             Extends         </div> <div style="text-align: center; margin-right: 10px;"> <br/>             Retracts         </div> </div> <ul style="list-style-type: none"> <li>12 Firmware version</li> <li>13 Input signal</li> <li>14 Output signal</li> <li>15  Limit contact</li> <li>16 DIN test with register number (only version with "actuator stem extends" fail-safe action)</li> <li>17 Other mark of conformity</li> </ul> |
|--|--|

## Markings on the device

### 2.2 Device code

Electric actuator	Type 5827-	x	x	x
Fail-safe action				
Without	N			
Actuator stem extends	A			
Actuator stem retracts	E			
Rated travel/adaptation				
6 mm/force locking			1	
12 mm/force locking			2	
15 mm/form-fit			3	
Control/supply voltage				
Digital positioner/24 V AC and DC				4
Digital positioner/85 to 264 V AC				5



### 3 Design and principle of operation

A stepper motor allows for supply by frequency-independent voltages. The force of the motor is transmitted to the actuator stem (3) via gear and crank disk. When the actuator stem extends, the actuator piston (3) pushes against the valve's plug stem.

When the actuator stem retracts (force-locking attachment), the plug stem follows the movement of the actuator stem as a result of the return spring in the valve.

When the actuator stem retracts (form-fit attachment), the plug stem is connected to the actuator stem and follows its movement.

The positioner ensures a predetermined assignment of the valve position to the input signal. For position feedback, a 0 to 10 V signal can be picked off at terminals 32 and 33.

The characteristic and the input and output signal settings can be changed using the TROVIS-VIEW software (► EB 6661).

#### Version without fail-safe action

The actuator without fail-safe action has a handwheel (2) used to manually position the valve. Travel and direction of action can be read off the travel indication scale (9).

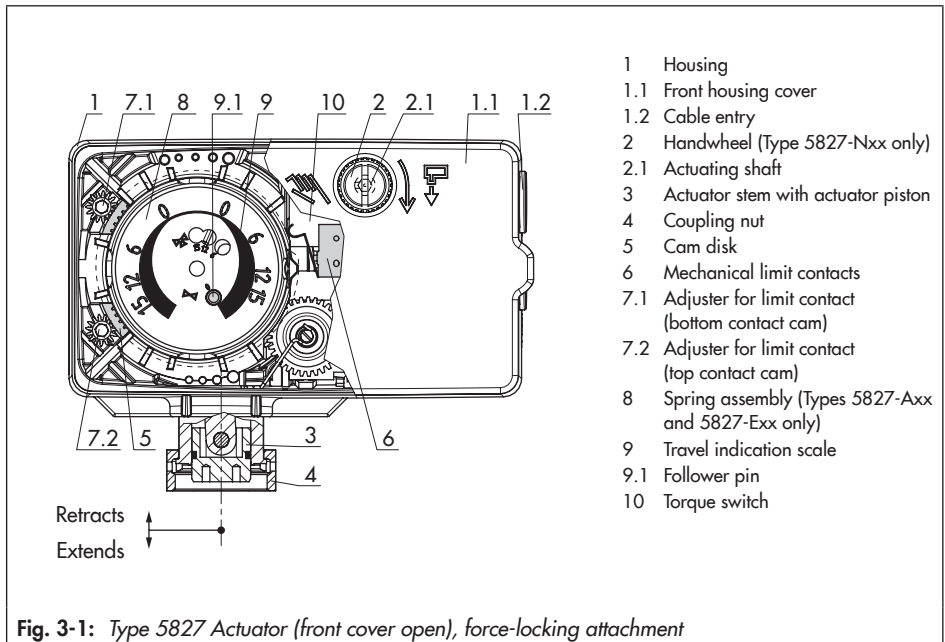

### 3.1 Fail-safe action

The actuator version with fail-safe action contains a spring assembly (8, see Fig. 3-1) and an electromagnet. The actuator is moved by the force of the spring to the fail-safe position when the electromagnet (terminals L and N) is de-energized. The direction of action depends on the actuator version and cannot be reversed.

The actuator is available with the following fail-safe actions:

**Actuator stem extends:** upon supply voltage failure, the actuator stem extends.

**Actuator stem retracts:** upon supply voltage failure, the actuator stem retracts.

#### **⚠ NOTICE**

**Increased wear and shortened service life of the actuator.**

→ Do not use the fail-safe action to control the valve position.

The actuator version with fail-safe action does not have a handwheel (2) on the front housing cover. Manual override is possible, after removing the front cover, using a 4 mm Allen key. The actuator returns to its original position as soon as the Allen key is released.

#### **Testing according to DIN EN 14597**

The Type 5827 Electric Actuator with fail-safe action "actuator stem extends" is tested by the German technical surveillance association TÜV according to DIN EN 14597 in combination with different SAMSON valves (the register number is available on request).

### 3.2 Communication

#### **Serial interface**

The actuator is fitted with an RS-232 serial interface. This allows communication with TROVIS-VIEW using SSP protocol (see Fig. 3-2).

#### **⚠ WARNING**

**Risk of injury due to a power surge.**

The serial interface of the electric actuator is not fitted with a surge protector.

→ Ensure that surge protection is provided upon connecting cables.

#### **⚠ NOTICE**

**Risk of damage to the electric actuator due to overvoltage.**

→ Ensure that surge protection is provided upon connecting cables.

#### **i Note**

The serial interface is exclusively intended for servicing purposes. It must only be used temporarily and not permanently.

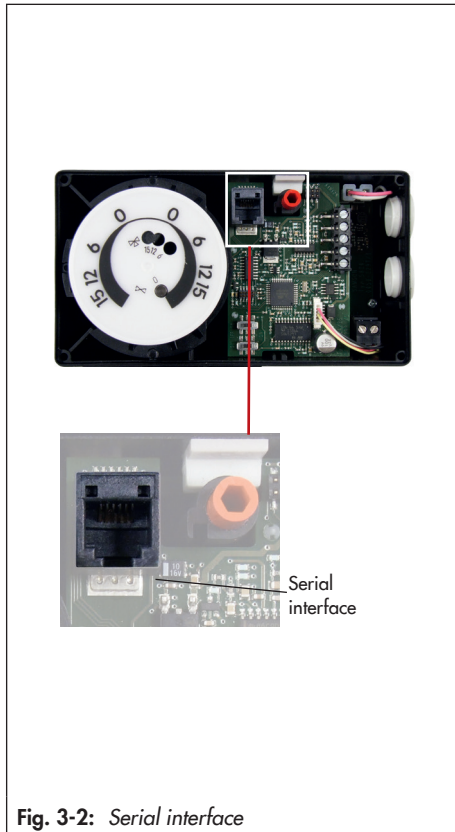

Fig. 3-2: Serial interface

### Configuration

The actuator is configured with the TROVIS-VIEW software. In this case, the serial interface on the actuator is used to connect the actuator to the computer.

The TROVIS-VIEW software enables the user to easily configure the positioner as well as view process parameters online.

### **i** Note

TROVIS-VIEW can be downloaded free of charge from our website at  
 ▶ [www.samsongroup.com](http://www.samsongroup.com) > Service & Support > Downloads > TROVIS-VIEW. Further information on TROVIS-VIEW (e.g. system requirements) is available on our website and in the Data Sheet ▶ T 6661 as well as the Operating Instructions ▶ EB 6661.

➔ See the 'Start-up and configuration' section.

## 3.3 Additional equipment

### Limit contacts

Devices in 24 V version can be fitted with limit contacts. The limit contacts consist of two changeover switches. Their switching positions are changed independently from one another by continuously adjustable cam disks. The floating contacts can be used as either make or break contacts to influence the tasks of control equipment.

The adjustment of the limit contacts is described in the 'Installation' section.

It is not possible to retrofit limit contacts.

### 3.4 Technical data

**Table 3-1:** *Technical data · Type 5827-Nxx, version without fail-safe action*

Type 5827-N			14	15	24	25	34	35
Rated travel	mm		6 <sup>1)</sup>	6 <sup>1)</sup>	12	12	15	15
Thrust	Extends	N	700	700	700	700	700	700
	Retracts	N	–	–	–	–	700	700
Manual override			Yes					
Stroking speed <sup>2)</sup>	Slow	mm/s	0.13	0.13	0.13	0.13	0.13	0.13
	Standard	mm/s	0.2	0.2	0.2	0.2	0.2	0.2
	Fast	mm/s	0.36	0.36	0.36	0.36	0.36	0.36
Transit time for rated travel	Slow	s	45	45	89	89	111	111
	Standard	s	31	31	61	61	76	76
	Fast	s	17	17	33	33	41	41
Attachment	Force-locking		•	•	•	•	–	–
	Form-fit		–	–	–	–	•	•
Supply voltage								
24 V (±10 %), 50 and 60 Hz			•	–	•	–	•	–
24 V DC (–10/+20 %)			• <sup>3)</sup>	–	• <sup>3)</sup>	–	• <sup>3)</sup>	–
100 to 240 V (tolerance 85 to 264 V) 50 to 60 Hz (tolerance 47 to 63 Hz)			–	•	–	•	–	•
Power consumption	VA		5 <sup>4)</sup>	8	5 <sup>4)</sup>	8	5 <sup>4)</sup>	8
Weight	kg		0.75	0.75	0.75	0.75	0.75	0.75
Additional equipment <sup>5)</sup>								
Two limit contacts, max. 230 V, max. 1 A, without contact protection <sup>6)</sup>			•	–	•	–	•	–

1) Actuators with 6 mm travel can also be used for valves with 7.5 mm travel (45 s transit time, 22.5 s for actuator with faster motor).

2) Adjustable

3) When the fast stroking speed setting is selected, the supply voltage must not fall below the specified value.

4) Power consumption of 24 V DC version specified in W

5) Cannot be retrofitted

6) The operator is responsible for the contact protection since it varies depending on the type of load. The switching output of the control equipment must be protected accordingly.

**Table 3-2:** Technical data · Type 5827-Axx, version with "actuator stem extends" fail-safe action

Type 5827-A			14	15	24	25	34	35
Actuation			Positioner					
Rated travel	mm		6 <sup>1)</sup>	6 <sup>1)</sup>	12	12	15	15
Thrust	Extends	N	500	500	500	500	280	280
	Retracts	N	–	–	–	–	280	280
Thrust in the event of fail-safe action		N	500	500	500	500	280	280
Manual override			Possible <sup>2)</sup>					
Stroking speed <sup>3)</sup>	Slow	mm/s	0.13	0.13	0.13	0.13	0.13	0.13
	Standard	mm/s	0.2	0.2	0.2	0.2	0.2	0.2
	Fast	mm/s	0.36	0.36	0.36	0.36	0.36	0.36
Transit time for rated travel	Slow	s	45	45	89	89	111	111
	Standard	s	31	31	61	61	76	76
	Fast	s	17	17	33	33	41	41
Transit time for rated travel in the event of fail-safe action		s	4	4	6	6	7	7
Attachment	Force-locking		•	•	•	•	–	–
	Form-fit		–	–	–	–	•	•
Supply voltage								
24 V (±10 %), 50 and 60 Hz			• <sup>4)</sup>	–	• <sup>4)</sup>	–	•	–
24 V DC (–10/+20 %)			• <sup>5)</sup>	–	• <sup>5)</sup>	–	• <sup>5)</sup>	–
100 to 240 V (tolerance 85 to 264 V) 50 to 60 Hz (tolerance 47 to 63 Hz)			–	•	–	•	–	•
Power consumption	VA		8 <sup>6)</sup>	10	8 <sup>6)</sup>	10	8 <sup>6)</sup>	10
Weight	kg		1	1	1	1	1	1
Additional equipment <sup>7)</sup>								
Two limit contacts, max. 230 V, max. 1 A, without contact protection <sup>8)</sup>			•	–	•	–	•	–
Testing according to DIN EN 14597			•	•	•	•	–	–

1) Actuators with 6 mm travel can also be used for valves with 7.5 mm travel (45 s transit time, 22.5 s for actuator with faster motor).

2) Manual override with a 4 mm Allen key

3) Adjustable

4) Voltage tolerance for actuators tested according to DIN EN 14597: –15/+10 %

5) When the fast stroking speed setting is selected, the supply voltage must not fall below the specified value.

6) Power consumption of 24 V DC version specified in W

7) Cannot be retrofitted

8) The operator is responsible for the contact protection since it varies depending on the type of load. The switching output of the control equipment must be protected accordingly.

## Design and principle of operation

**Table 3-3:** Technical data · Type 5827-Exx, version with "actuator stem retracts" fail-safe action

Type 5827-E			14	15	24	25	34	35
Rated travel	mm		6 <sup>1)</sup>	6 <sup>1)</sup>	12	12	15	15
Thrust	Extends	N	500	500	500	500	280	280
	Retracts	N	–	–	–	–	280	280
Thrust in the event of fail-safe action		N	–	–	–	–	280	280
Manual override			Possible <sup>2)</sup>					
Stroking speed <sup>3)</sup>	Slow	mm/s	0.13	0.13	0.13	0.13	0.13	0.13
	Standard	mm/s	0.2	0.2	0.2	0.2	0.2	0.2
	Fast	mm/s	0.36	0.36	0.36	0.36	0.36	0.36
Transit time for rated travel	Slow	s	45	45	89	89	111	111
	Standard	s	31	31	61	61	76	76
	Fast	s	17	17	33	33	41	41
Transit time for rated travel in the event of fail-safe action		s	4	4	6	6	7	7
Attachment	Force-locking		•	•	•	•	–	–
	Form-fit		–	–	–	–	•	•
Supply voltage								
24 V (±10 %), 50 and 60 Hz			•	–	•	–	•	–
24 V DC (–10/+20 %)			• <sup>4)</sup>	–	• <sup>4)</sup>	–	• <sup>4)</sup>	–
100 to 240 V (tolerance 85 to 264 V) 50 to 60 Hz (tolerance 47 to 63 Hz)			–	•	–	•	–	•
Power consumption	VA		8 <sup>5)</sup>	10	8 <sup>5)</sup>	10	8 <sup>5)</sup>	10
Weight	kg		1	1	1	1	1	1
Additional equipment <sup>6)</sup>								
Two limit contacts, max. 230 V, max. 1 A, without contact protection <sup>7)</sup>			•	–	•	–	•	–

1) Actuators with 6 mm travel can also be used for valves with 7.5 mm travel (45 s transit time, 22.5 s for actuator with faster motor).

2) Manual override with a 4 mm Allen key

3) Adjustable

4) When the fast stroking speed setting is selected, the supply voltage must not fall below the specified value.

5) Power consumption of 24 V DC version specified in W

6) Cannot be retrofitted

7) The operator is responsible for the contact protection since it varies depending on the type of load. The switching output of the control equipment must be protected accordingly.

**Table 3-4:** *Technical data for all versions*

Type 5827-N/-A/-E	All versions
Positioner	
Input signal	0 to 10 V, $R_i = 20 \text{ k}\Omega$ · 0 to 20 mA, $R_i = 50 \Omega$
Output signal	0 to 10 V, $R_b = 1 \text{ k}\Omega$
Safety	
Degree of protection	IP54 according to EN 60529 <sup>1)</sup>
Class of protection	II according to EN 61140 <sup>1)</sup>
Degree of contamination	2 according to EN 60664-1
Noise immunity	According to EN 61000-6-2 and EN 61326-1
Noise emission	According to EN 61000-6-3 and EN 61326-1
Electrical safety	According to EN 60730-1 and EN 60730-2-14
Rated surge voltage	2.5 kV according to EN 60730-1
Vibration	According to EN 60068-2-64 and EN 60068-2-27
Conformity	
Materials	
Housing, housing cover	Plastic (PPO with glass fiber reinforcement)
Coupling nut M32x1.5	Brass
Ambient conditions	
Permissible temperature ranges <sup>2)</sup>	
Ambient	0 to 50 °C
Storage	-20 to +70 °C
Humidity	5 to 95 % moisture, no dew formation
Max. altitude above sea level	2000 m

<sup>1)</sup> Only with closed and locked housing cover

<sup>2)</sup> The permissible medium temperature depends on the valve on which the actuator is mounted. The limits in the valve documentation apply.

### 3.5 Dimensions

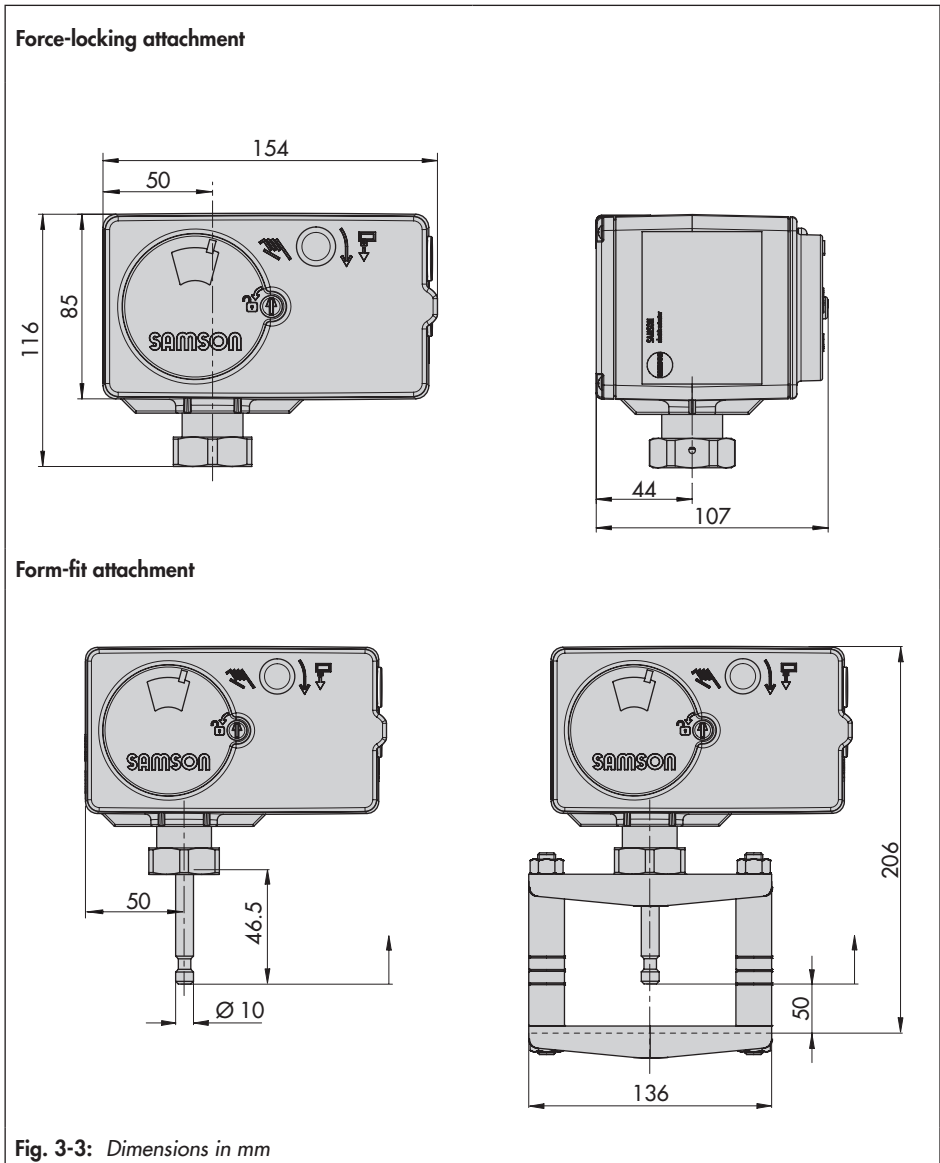



## 4 Shipment and on-site transport

The work described in this section is only to be performed by personnel appropriately qualified to carry out such tasks.

### 4.1 Accepting the delivered goods

After receiving the shipment, proceed as follows:

1. Compare the shipment received with the delivery note.
2. Check the shipment for transportation damage. Report any damage to SAMSON and the forwarding agent (refer to delivery note).

### 4.2 Removing the packaging from the actuator

#### **i** Note

Do not remove the packaging until immediately before mounting and start-up.

1. Remove the packaging from the electric actuator.
2. Check scope of delivery (see Fig. 4-1).
3. Dispose and recycle the packaging in accordance with the local regulations.

1x	Type 5827-xxx Electric Actuator
1x	Document IP 5827-2 (Important Product Information)

Fig. 4-1: Scope of delivery

### 4.3 Transporting the actuator

- Protect the electric actuator against external influences (e.g. impact).
- Protect the electric actuator against moisture and dirt.
- Observe the permissible transportation temperature of  $-20$  to  $+70$  °C.

### 4.4 Lifting the actuator

Due to the low service weight, lifting equipment is not required to lift the electric actuator.

### 4.5 Storing the actuator

#### **!** NOTICE

**Risk of electric actuator damage due to improper storage.**

- Observe the storage instructions.
- Avoid long storage times.
- Contact SAMSON in case of different storage conditions or longer storage times.

#### **i** Note

We recommend regularly checking the electric actuator and the prevailing storage conditions during long storage periods.

## Shipment and on-site transport

### Storage instructions

- Protect the electric actuator against external influences (e.g. impact).
- Protect the electric actuator against moisture and dirt.
- Make sure that the ambient air is free of acids or other corrosive media.
- Observe the permissible storage temperature from  $-20$  to  $+70$  °C.
- Do not place any objects on the electric actuator.

## 5 Installation

### 5.1 Installation conditions

#### Work position

If not described otherwise in the valve documentation, the work position for the control valve is the front view looking onto the operating controls.

#### Point of installation

The actuator is designed for installation in enclosed spaces.

#### Mounting orientation

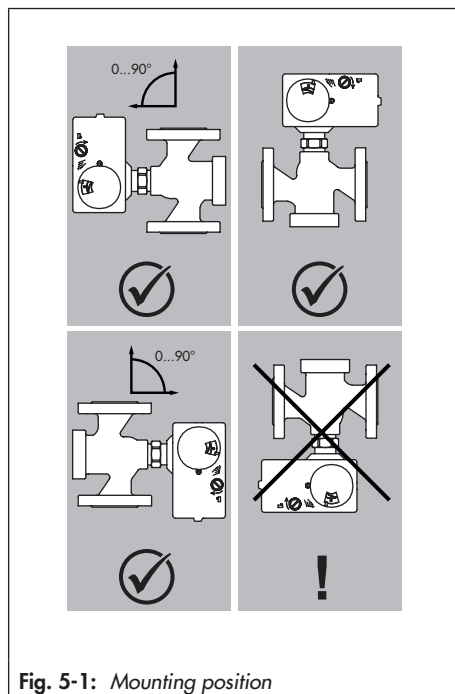

Fig. 5-1: Mounting position

The control valve can be installed in the pipeline in any desired position. However, a suspended mounting position of the actuator is not permissible (see Fig. 5-1).

#### NOTICE

**Risk of actuator damage due to adverse weather conditions.**

→ Do not use the actuator outdoors.

### 5.2 Preparation for installation

Before installation, make sure the following conditions are met:

- The actuator is not damaged.

Proceed as follows:

Lay out the necessary material and tools to have them ready during installation work.

- Flat-blade screwdriver with 0.8 mm blade thickness and 4.0 mm blade width
- Open-end wrench with width AF 32

#### Opening the front housing cover

The front housing cover of the actuator is secured by a quarter-turn fastener (see Fig. 5-2).

- Use a screwdriver to turn the quarter-turn fastener to the unlock symbol.
- Lift off the cover at the tab on the side of housing cover.

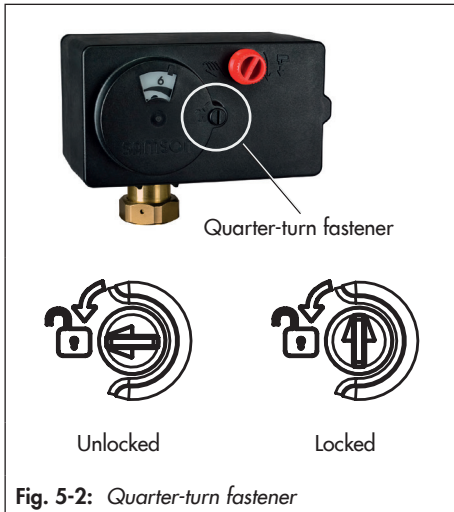

Fig. 5-2: Quarter-turn fastener

**NOTICE**

**Risk of actuator damage due to unauthorized opening of the back housing cover.**  
 → Do not open the back housing cover.

### 5.3 Aligning the travel indication scale

The travel indication scale has two opposed scales. Which scale is to be used depends on the valve version. In the delivered state, the scale alignment applies to globe valves and three-way diverting valves.

→ Change the alignment when a three-way mixing valve is used.

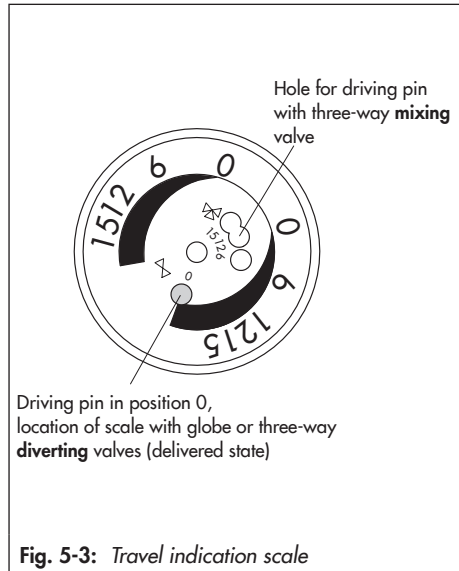

Fig. 5-3: Travel indication scale

**Globe and three-way diverting valves:**  
 the driving pin is in position 0 (delivered state).

**Three-way mixing valve:**  
 change the alignment of the scale.  
 → Carefully open the front housing cover.  
 → Remove scale, turn it and replace it so that the pin is positioned over the appropriate hole (6, 12 or 15) corresponding to the rated travel (6, 12 or 15 mm travel).

#### Closing the front housing cover

1. Position the front housing cover correctly and place it on the housing.
- Make sure that the quarter-turn fastener is turned to the unlocked position (see Fig. 5-2) and the handwheel (actua-

tors without fail-safe action) engages in the actuating shaft.

2. Turn the quarter-turn fastener to the locked position.

## 5.4 Mounting the actuator

The actuator is mounted either directly onto the valve or using a yoke depending on the valve version used (see Fig. 5-3).

### 5.4.1 Actuator without fail-safe action

#### 5.4.1.1 Force-locking attachment

1. Turn the handwheel (2) counterclockwise to retract the actuator stem.
2. Place the actuator on the valve connection and fasten with the coupling nut (4).

Tightening torque	20 Nm
-------------------	-------

#### 5.4.1.2 Form-fit attachment

1. Place the actuator on the yoke and fasten with the coupling nut (4).

Tightening torque	20 Nm
-------------------	-------

2. Place actuator with yoke (11) on the valve and fasten with the nut (13).

Tightening torque	150 Nm
-------------------	--------

#### **i** Note

A spacer (see Fig. 5-4) is required to mount a Type 3323 Three-way Valve (DN 65 to 80).

3. Pull plug stem until it reaches the actuator stem or extend actuator stem using the handwheel (2).
4. Position the clamps of the stem connector (12) included in the accessories on the ends of the actuator stem and plug stem and screw tight.

### 5.4.2 Actuator with fail-safe action

#### 5.4.2.1 Force-locking attachment

##### "Actuator stem extends" fail-safe action

The actuator stem must be retracted before the actuator can be mounted onto the valve. The stem can be retracted either mechanically or electrically. Both methods are described below.

##### Retracting the actuator stem mechanically

1. Unfasten the front housing cover and place a 4 mm Allen key on the red actuating shaft.
2. Retract the actuator stem: turn Allen key **counterclockwise** and **only as far as** the top end position which is at the point where the torque switch is activated (see the 'Operation' section).

#### **!** NOTICE

**Risk of damage to the actuator by moving the actuator stem too far.**

➔ Move the actuator stem only as far as the top end position.

## Installation

3. Hold Allen key in place and fasten valve and actuator together using the coupling nut.

Tightening torque	20 Nm
-------------------	-------

Remove Allen key and carefully replace the front housing cover.

### Retracting the actuator stem electrically

1. Remove the front housing cover.
2. Perform electrical wiring as described in section 5.6 and carefully replace the front housing cover.
3. Retract actuator stem:
  - Switch on the supply voltage and retract the actuator stem electrically until it reaches the end position by applying a signal to the input (see the 'Operation' section).
4. Fasten valve and actuator together using the coupling nut.

Tightening torque	20 Nm
-------------------	-------

### "Actuator stem retracts" fail-safe action

- Place the actuator on the valve connection and fasten with the coupling nut.

Tightening torque	20 Nm
-------------------	-------

### 5.4.2.2 Form-fit attachment

- Install as described in section 5.4.1.1.

## 5.5 Installing the control valve into the pipeline

---

### ! NOTICE

***Degree of protection not achieved due to incorrect mounting position.***

- *Install the control valve according to section 5.1.*

- 
- Install the valve into the pipeline according to the specifications in the mounting and operating instructions of the valve.

---

### ! NOTICE

***Risk of actuator damage due to direct contact with steam.***

- *During mounting, make sure that the actuator cannot come into contact with a jet of steam during operation.*
-

Force-locking attachment with coupling nut, e.g. to Type 3222 Valve

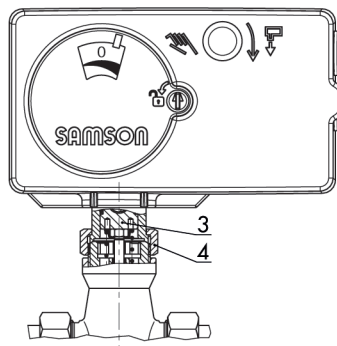

Form-fit attachment with stem connector, e.g. with yoke on Series V2001 Valve

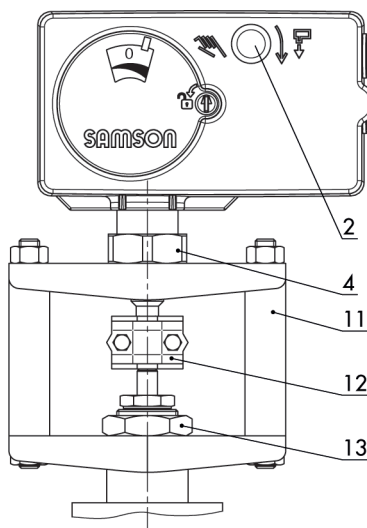

1) A spacer (see Annex) is required to mount a Type 3323 Three-way Valve (DN 65 to 80).

- 2 Handwheel
- 3 Actuator stem with actuator piston
- 4 Coupling nut
- 11 Yoke
- 12 Stem connector
- 13 Nut

Fig. 5-4: Mounting the actuator on the valve

## 5.6 Electrical connection

---

### DANGER

#### **Risk of fatal injury due to electric shock.**

- Upon installation of the electric cables, you are required to observe the regulations concerning low-voltage installations according to DIN VDE 0100 as well as the regulations of your local power supplier.
  - Use a suitable voltage supply which guarantees that no dangerous voltages reach the device in normal operation or in the event of a fault in the system or any other system parts.
  - Only perform the electrical connection after switching off the supply voltage. Make sure the supply voltage cannot be switched on again unintentionally.
  - Use cable glands with cable grip at the cable entry.
- 

### NOTICE

#### **Risk of actuator damage due to incorrect wiring of the inputs.**

- Wire the inputs range according to the technical data (see the 'Design and principle of operation' section).
- 

## Wiring

- Connect the wiring as shown in Fig. 5-5.
- 

### NOTICE

#### **Risk of actuator damage due to a short circuit.**

The supply voltage as well as the input and output signals are not galvanically isolated from one another.

- Do not apply any external voltage.
  - Do not connect terminals with each other.
  - Make sure that the single wires of multi-wire cables do not touch neighboring terminals.
-



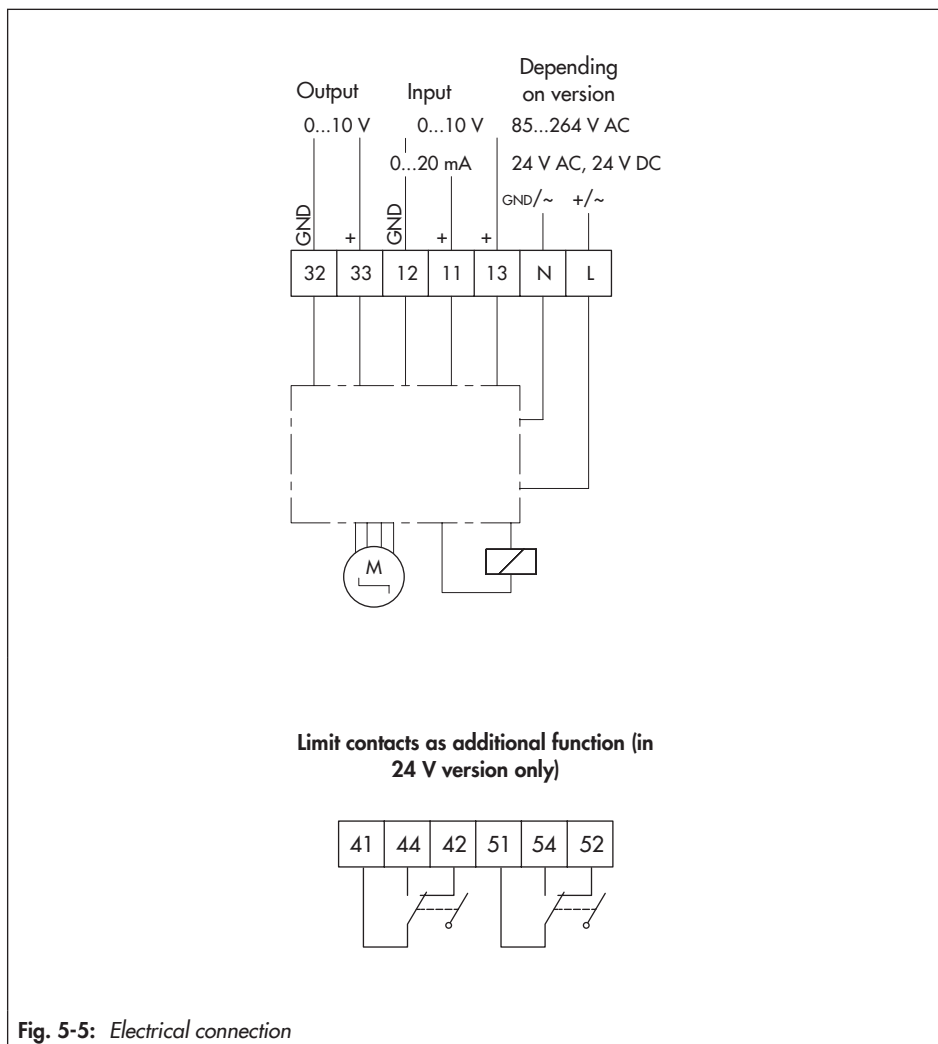
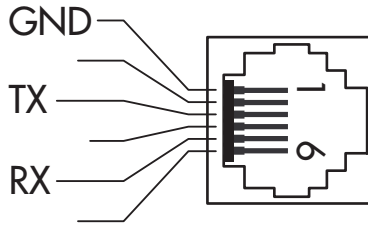

Fig. 5-5: Electrical connection

**i Note**

The 24 V version can be used either with a supply voltage of 24 V AC or 24 V DC.



**Fig. 5-6:** Terminal assignment of RJ-12 jack

**Table 5-1:** Cables and stranded wires that can be used

Cable	Cross section
With terminals for control and supply	
<b>Types 5827-xx4</b>	
Single-wire H05(07) V-U	0.5 to 1.5 mm <sup>2</sup>
Fine-wire H05(07) V-K	0.5 to 1.5 mm <sup>2</sup>
Length of insulation to be stripped off wire ends: 6 mm (±0.5 mm)	
<b>Types 5827-xx5</b>	
Single-wire H05(07) V-U	0.5 to 2.5 mm <sup>2</sup>
Fine-wire H05(07) V-K	0.5 to 2.5 mm <sup>2</sup>
Length of insulation to be stripped off wire ends: 8 mm	
With terminals for limit contacts	
Single-wire H05(07) V-U	0.2 to 1.5 mm <sup>2</sup>
Fine-wire H05(07) V-K	0.2 to 1.5 mm <sup>2</sup>
With wire ferrule acc. to DIN 46228-1	0.25 to 1.5 mm <sup>2</sup>
With wire ferrule and sleeve acc. to DIN 46228-4	0.25 to 0.75 mm <sup>2</sup>
Length of insulation to be stripped off wire ends: 8 mm	

## 6 Operation

### 6.1 Device overview and operating controls



## 6.1.1 Indication with LEDs

The actuator has a red and a yellow LED which indicate the operating state of the actuator through a blinking pattern. The LEDs are located underneath the cover on top of the actuator.

**!** NOTICE

**Specified degree of protection does not apply when the housing cover is open.**

→ Ensure that no moisture or foreign particles can get into the actuator.

LEDs under the front housing cover (24 V version)

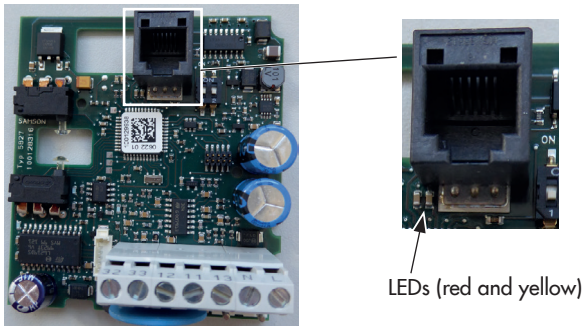
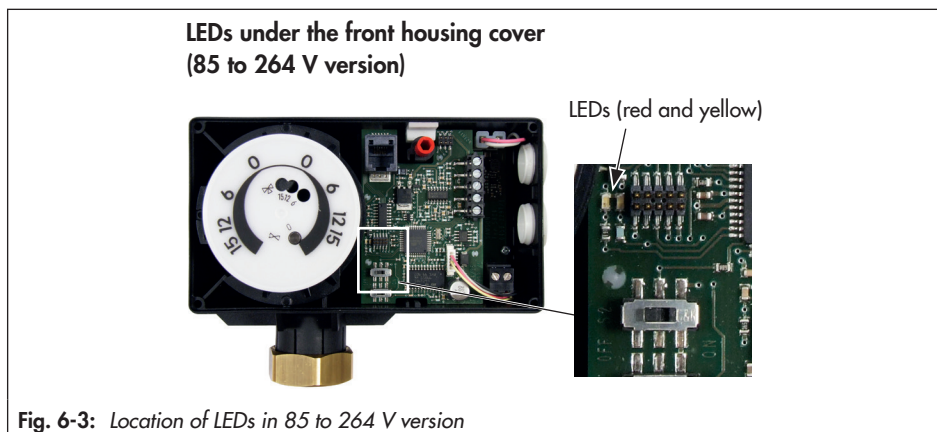

Fig. 6-2: Location of LEDs in 24 V version

**i** Note

The current 24 V version of the electric actuator is shown in Fig. 6-2. The images und descriptions that apply to previous versions of the actuator are included in Annex A.



## 6.1.2 Function switch

The function switch has the following functions:

1. Determining the input signal range
2. Starting initialization (see the 'Start-up and configuration' section).
  - **Switch position 1 or A (default):**
    - Input signal 0 to 10 V or 0 to 20 mA
    - Input signal settings in TROVIS-VIEW **are taken into account.**
  - **Switch position ON or B:**
    - Input signal 2 to 10 V or 4 to 20 mA
    - Input signal settings in TROVIS-VIEW **are ignored.**

### ⓘ NOTICE

**Specified degree of protection does not apply when the housing cover is open.**

→ Ensure that no moisture or foreign particles can get into the actuator.

**Function switch (24 V version)**

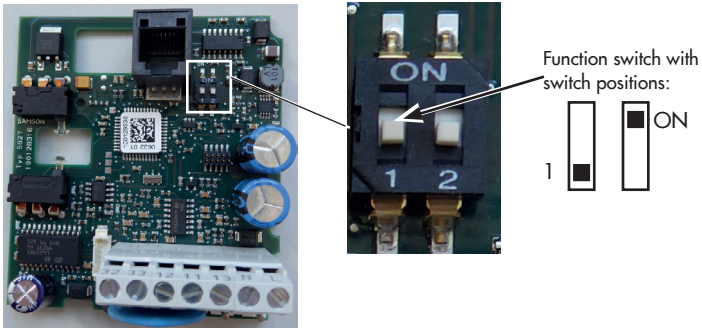
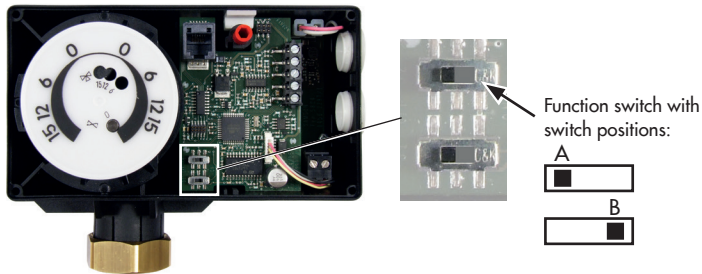

**Fig. 6-4:** Function switch (24 V version)

**i Note**

The current 24 V version of the electric actuator is shown in Fig. 6-4. The images and descriptions that apply to previous versions of the actuator are included in Annex A.

**Function switch (85 to 264 V version)**



**Fig. 6-5:** Function switch (85 to 264 V version)

### 6.1.3 Direction of action switch

The position of the direction of action switch determines the actuator's direction of action.

- **Switch position 2 or A (default):** direction of action increasing/increasing (>>)  
→ The actuator stem retracts as the input signal increases.
- **Switch position ON or B:** Direction of action increasing/decreasing (<>)  
The actuator stem extends as the input signal increases.

#### ! NOTICE

**Specified degree of protection does not apply when the housing cover is open.**

→ Ensure that no moisture or foreign particles can get into the actuator.

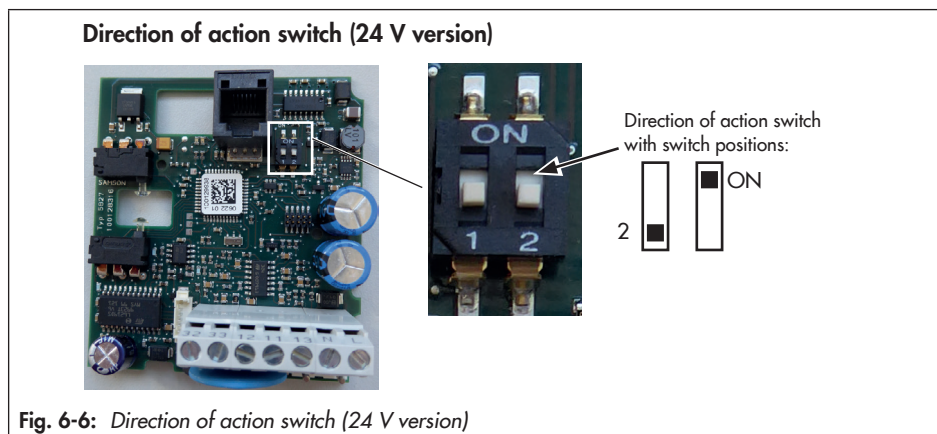

**Fig. 6-6:** Direction of action switch (24 V version)

#### i Note

The current 24 V version of the electric actuator is shown in Fig. 6-6. The images and descriptions that apply to previous versions of the actuator are included in Annex A.

Direction of action switch (85 to 264 V version)

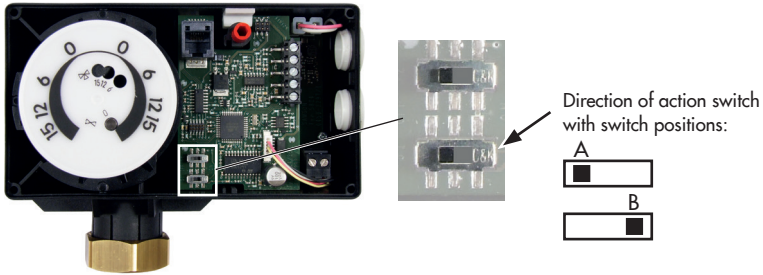

Fig. 6-7: Direction of action switch (85 to 264 V version)

### 6.1.4 Actuating shaft (opened front housing cover)

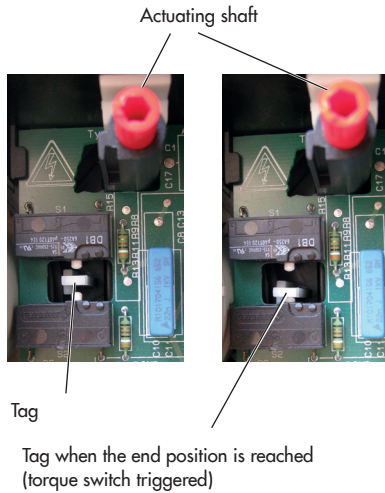

Fig. 6-8: Actuating shaft and torque switches



## 7 Start-up and configuration

### 7.1 Initializing the actuator

To achieve correct position feedback, the actuator must be initialized. This is also necessary after changing the configuration at the actuator.

The actuator can be initialized at the actuator itself or over the TROVIS-VIEW software.

#### **⚠ WARNING**

**Risk of injury due to the actuator stem extending or retracting (with form-fit attachment).**

*Directly after connecting the supply voltage, the actuator stem can start to move.*

→ *Do not touch or block the actuator stem.*

#### **ⓘ NOTICE**

**The process is disturbed by the movement of the actuator stem.**

→ *Do not perform the initialization while the process is running. First isolate the plant by closing the shut-off valves.*

#### Start initialization

1. Place the function switch into the required position.
2. Switch the function switch briefly from its position to the other position and back again (see Fig. 7-2).

The **red LED** indicates that initialization is in progress (see Fig. 7-1).

#### **i Note**

The actuator automatically performs a zero calibration as soon as the supply voltage is applied to the L and N terminals. This is indicated by the red LED blinking (see the 'Operation' section). This function does not replace the initialization procedure.

#### **ⓘ NOTICE**

**Risk of malfunction due to incomplete or incorrect start-up.**

→ *Start initialization*

→ *Complete the entire initialization procedure until the red LED is no longer illuminated.*

*The actuator is not ready to use until the initialization is completed.*

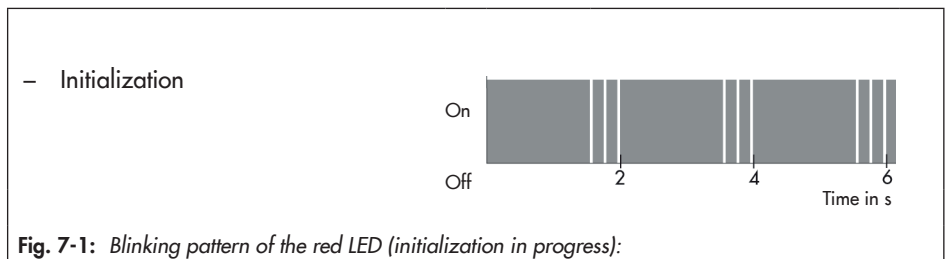

### Function switch (24 V version)

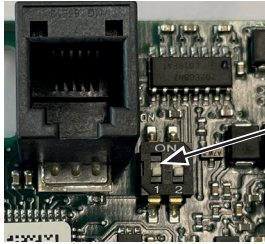

Function switch with switch positions:



### Function switch (85 to 264 V version)

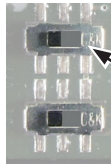

Function switch with switch positions:



1/A = 0 to 10 V/0 to 20 mA

ON/B = 2 to 10 V/4 to 20 mA

Fig. 7-2: Function switch

## 7.2 Configuring the actuator

The actuator is configured with the TROVIS-VIEW software (see Annex A). In this case, the serial interface on the actuator is used to connect the actuator to the computer (see the 'Design and principle of operation' section).

→ Refer to ► EB 6661 for more details on configuration and operation using TROVIS-VIEW.

## 7.3 Adjusting the limit contacts

### **⚠ DANGER**

*Risk of fatal injury due to electric shock from exposed live parts.*

→ Do not touch live parts on adjusting the limit contacts.

The limit contacts (see the 'Design and principle of operation' section) can optionally be used as make or break contacts.

**Terminal assignment (see the 'Installation' section):**

- Terminals 41, 44, 42:  
→ Bottom cam disk, adjuster 7.1
  - Terminals 51, 54, 52:  
→ Top cam disk, adjuster 7.2
1. Remove the front housing cover.
  2. Move the actuator stem to the position at which switching point is to be activated.
  3. Use a 4 mm Allen key to turn the adjusters (see the 'Design and principle of operation' section) up to the point where the contact is triggered.

### **💡 Tip**

*The angle of rotation of the cam disks is limited. Therefore, use preferably the adjuster (7.1) for the lower travel range and the adjuster (7.2) for the upper travel range (see Fig. 7-3).*

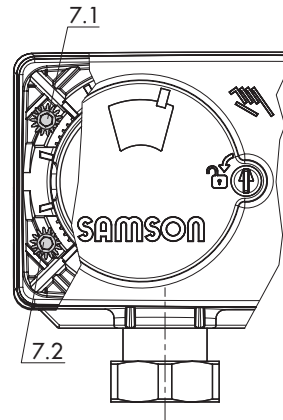

- 7.1 Adjuster for limit contact (bottom contact cam)
- 7.2 Adjuster for limit contact (top contact cam)

**Fig. 7-3:** Adjusters for limit contacts

### Switching point of the lower limit contact

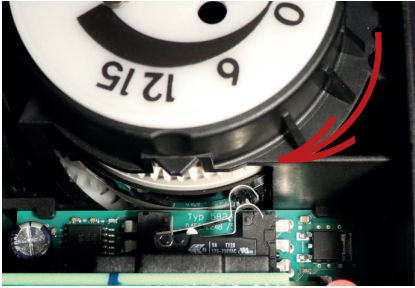

- Activated by the bottom cam disk at 0 % travel when moving in the direction indicated by the arrow
- Lower limit contact is active when the actuator stem is extended.
- Adjustable with adjuster 7.1
- Contacts 41/44 closed when the switch is active

### Switching point of the upper limit contact

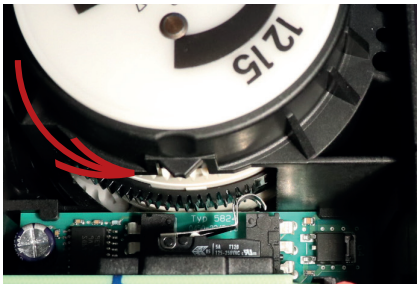

- Activated by the top cam disk at 100 % travel when moving in the direction indicated by the arrow
- Upper limit contact is active when the actuator stem is retracted.
- Adjustable with adjuster 7.2
- Contacts 51/54 closed when the switch is active

### Limit contacts inactive

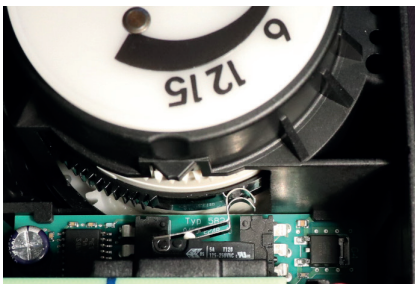

- Not activated by the cam disks
- Both limit contacts inactive
- Contacts 41/42 closed (lower limit contact)
- Contacts 51/52 closed (upper limit contact)

Fig. 7-4: Switching points of the limit contacts

## 8 Operation

After applying the supply voltage, the actuator is ready for use.

### 8.1 Positioner

The actuator stem's position directly follows the input signal.

### 8.2 LED blinking pattern

#### Explanations to the blinking pattern of the LEDs

The state of the corresponding LED (on/off) is shown over time.

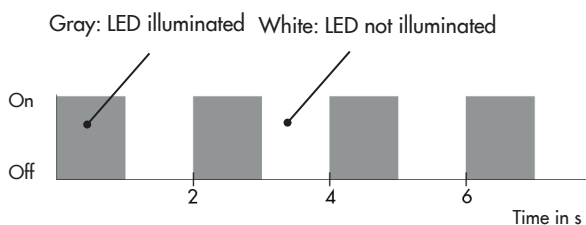

#### Blinking pattern of the yellow LED

- Device ON

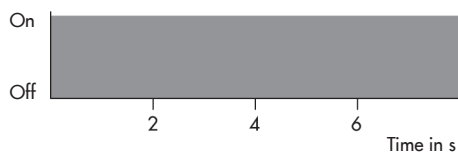

- Stem position is relative

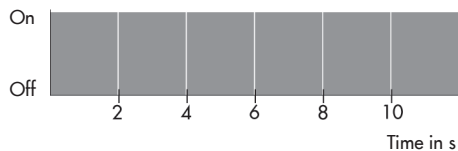

- Protecting against blockage

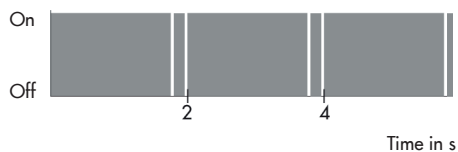

## Operation

### Blinking pattern of the red LED

- Device restarts after reset
- Zero calibration in progress
- Transit time measurement in progress
- Initialization in progress

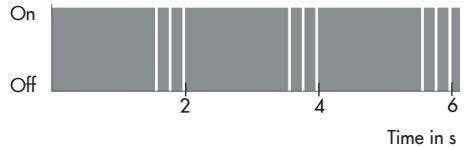
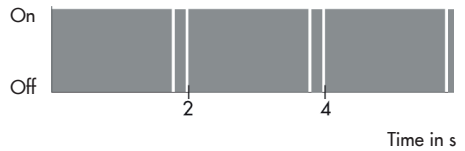
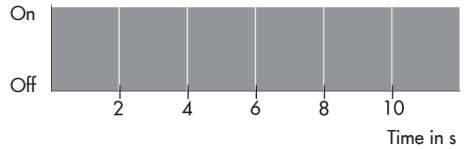
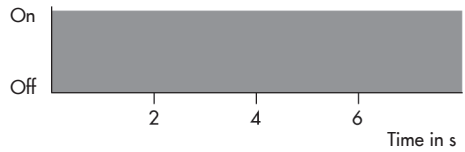

#### **i** Note

The LED blinking patterns apply when the memory pen is inserted into the actuator (see section 8.4).

## 8.3 Manual override

The actuator stem can be moved mechanically or alternatively electrically in the manual level in TROVIS-VIEW (► EB 6661).

Travel and direction of action can be read off the scale of the travel indicator.

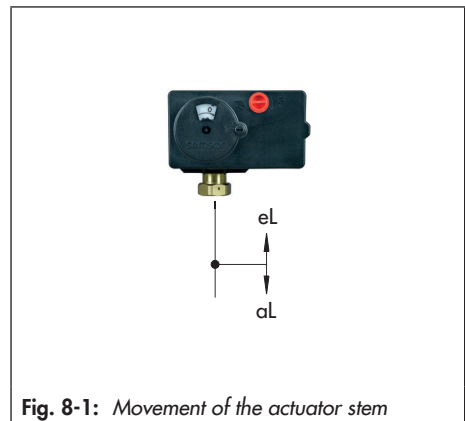

**Fig. 8-1:** Movement of the actuator stem

### 8.3.1 Mechanical override

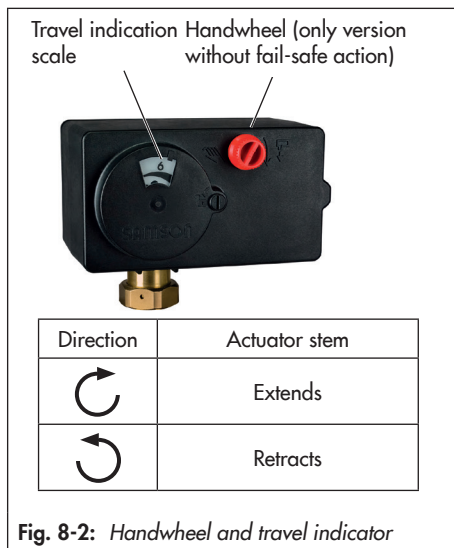

Fig. 8-2: Handwheel and travel indicator

#### Direction of rotation

- Turn clockwise: the actuator stem extends (see Fig. 8-2).
- Turn counterclockwise: the actuator stem retracts (see Fig. 8-2).

#### Actuator without fail-safe action

To manually move the actuator stem one millimeter, the handwheel must be turned approx. 4 turns (see Fig. 8-2):

#### **i** Note

The positioning of the valve is affected when the handwheel is operated while the process is running. As a result, zero point and the position feedback do not match the calibrated values. Zero calibration, initialization or a transit time measurement must be performed again.

#### Actuator with fail-safe action

The front housing cover must be opened before manually adjusting the actuator stem. The stem can be moved manually one millimeter by turning the actuating shaft approx. 4 turns using an Allen key.

#### **!** NOTICE

**Specified degree of protection does not apply when the housing cover is open.**

➔ Ensure that no moisture or foreign particles can get into the actuator.

#### **!** DANGER

**Risk of electric shock from exposed live parts.**

➔ Do not touch live parts on operating the manual override.

1. Unfasten the front housing cover and place a 4 mm Allen key on the red actuating shaft.

---

### ⓘ NOTICE

***Risk of damage to the actuator by moving the actuator stem too far.***

→ Only extend or retract the actuator stem as far as the final travel value.

---

2. Use the Allen key to turn the actuating shaft:
  - Turn it counterclockwise only for a version with fail-safe action "actuator stem extends".
  - Turn it clockwise only for a version with fail-safe action "actuator stem retracts".
3. Turn the Allen key only as far as the final travel value, which is at the point where the torque switch is activated.
  - Once the magnet has been released, the spring mechanism pushes the actuator stem back to the fail-safe position.
4. Remove Allen key and carefully replace the front housing cover.

## 8.4 Operation using memory pen

▶ EB 6661

---

### ⓘ NOTICE

***Specified degree of protection does not apply when the housing cover is open.***

→ Ensure that no moisture or foreign particles can get into the actuator.

---

The memory pen can be loaded with data configured in TROVIS-VIEW and the configuration data transferred to one or several devices of the same type and version.

Additionally, the data from the device can be written to the memory pen. This allows the configuration data to be simply copied from one device and loaded onto other devices of the same type and version.

The data logging function also allows operating data to be recorded.

---

### ⓘ Note

*On inserting a memory pen that is empty or that contains data from another type of device or another version of the same device into the serial interface port of the actuator, the data from the actuator are uploaded to the memory pen regardless of the status of the memory pen and any other data on the memory pen will be overwritten.*

---



### LED blinking pattern for the memory pen

Memory pen actions and errors are indicated at the **yellow LED** on the actuator.

- Memory pen action completed

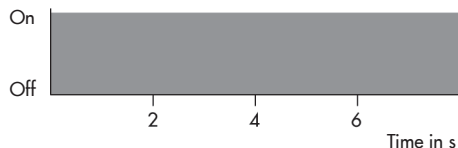

- Preparing to read from memory pen

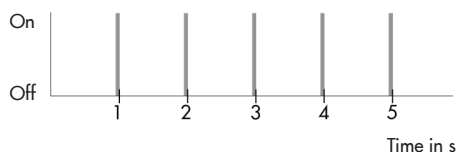

- Preparing to write data to memory pen

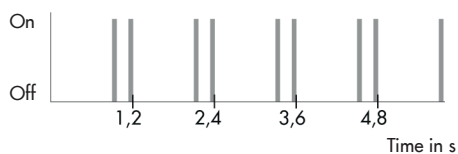

- Preparing data logging

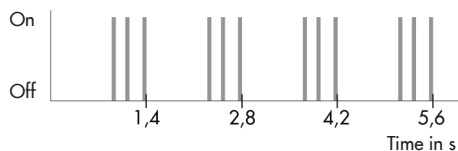

- Data logging in progress

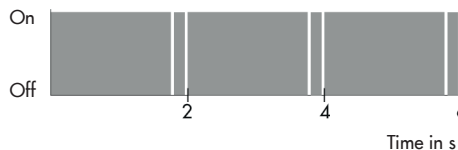

### Data transmission between the actuator and memory pen

The memory pen is connected to the actuator as shown in Fig. 8-3. Refer to the TROVIS-VIEW Operating Instructions ► EB 6661 on how to transfer data.

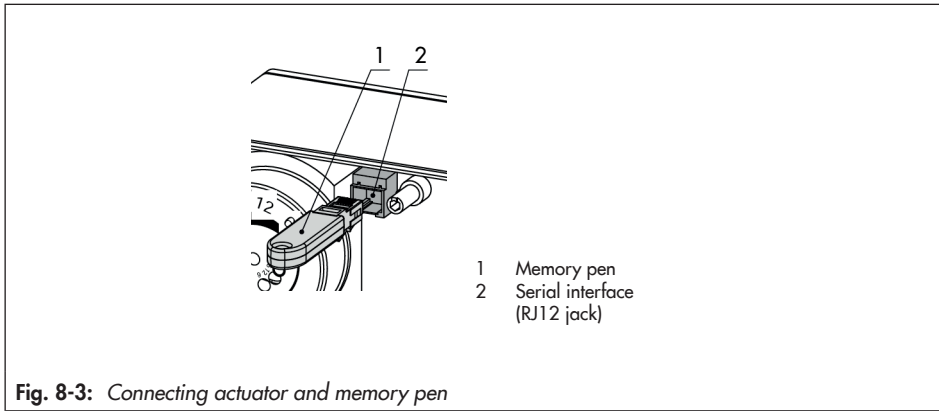

The **yellow LED** on the actuator indicates that the data logging is being prepared. Data transmission is completed when the **yellow LED** is illuminated continuously (see the 'Operation' section).

### 8.4.1 Copying function

The memory pen can be used to copy setting data to other Types 5827 Actuators after the data from the actuator have been transferred to the memory pen.

---

#### **i Note**

*"Automatically write to memory pen" is automatically reset to the read status after data are transferred from the actuator for the first time.*

---

## 8.4.2 Data logging

The memory pen-64 allows the following data to be saved:

- Input in %
- Actuator travel in %
- Position feedback in %
- Temperature inside device in °C
- Torque switch: Actuator stem retracted
- Torque switch: Actuator stem extended
- Position feedback is relative
- Malfunctions
- Input signal failure
- Direction of action switch
- Function switch initialization

The data are logged until the memory capacity of the memory pen is full.

Data in the memory pen can be saved to a data logging file using the TROVIS-VIEW software.

### Data logging

1. Plug the memory pen into the serial interface of the actuator (Fig. 8-3).  
The **yellow LED** on the actuator indicates that the data logging is being prepared (see section 8.4).  
A change in the blinking pattern of the **yellow LED** indicates that data are being saved to the memory pen.
2. Data logging is completed when you remove the memory pen from the serial interface of the actuator.

---

**i Note**

*You can load a data logging file into the Trend-Viewer by selecting Load diagram ... from the context-sensitive menu in TROVIS-VIEW.*

---

## Operation

### Transferring data onto a computer

1. Insert the memory pen together with modular adapter into the serial interface (COM port) of the computer (see Annex for accessories).
2. Select 'Read Logged Data' from the 'Memory Pen' menu.
3. Select the desired target directory. If the target directory is not changed, data will be saved in the SAMSON folder > Type 5827.
4. Enter the file name.
5. Click 'Save' to start data transmission.

### 8.4.3 Command mode

In closed-loop operation, the actuator stem can be moved to the top or bottom end position using the command pen regardless of the input signal.

Possible settings:

- No command
- Retract actuator stem
- Extend the actuator stem

## 8.5 Readings in TROVIS-VIEW

### 8.5.1 Operating values

---

**i Note**

*The values in the Operating values folder cannot be changed.*

---

In **online mode**, the current operating values are listed in the 'Operating values' folder. Depending on the basic setting, a graph is shown under the 'Operating values' window.

### 8.5.2 Operating states

Error messages can be read in the 'Service' folder ('Operating states').

---

**i Note**

*Operating states and errors are also indicated by the LEDs (see section 8.2).*

---

### 8.5.3 Status messages

In the 'Service' folder ('Status messages'), device and operation parameters are shown.

<b>Device</b>	Firmware version	
	Serial number	
	Device information	
	Manufacturing parameters	
<b>Operation</b>	Operating hours	in h
	Operating hours at excess temperature	in h
	Temperature inside device	in °C
	Highest temperature inside device	in °C
	Lowest temperature inside device	in °C
<b>Actuator strokes</b>	Motor running time	in h
	Attempts	
	Changes in direction	
<b>Valve strokes</b>	Full travel cycles	
<b>LEDs</b>	Yellow	
	Red	

## 8.5.4 Statistics

In the 'Service folder' ('Statistics'), various readings of counters are shown:

<b>Device failures counters</b>	Supply voltage activated
	Program interruptions
	Limit contact error
	EPROM error
<b>Alarms counters</b>	Input signal failures
<b>Counter: switch</b>	Direction of action switch
	Function switch
	Initialization
<b>Counter: manual overrides</b>	Manual overrides
<b>Memory pen counters</b>	Command retract stem
	Command extend stem
	Data read
	Data written
	Data logged
<b>Functions counter</b>	Basic settings changed
	Settings changed
	Manual level activated
	Zero calibration started
	Initialization started
	Reset triggered
	Default settings loaded
	Transit time measurement started

## 9 Malfunctions

→ Troubleshooting (see Table 9-1).

### **i** Note

Contact SAMSON's After-sales Service for malfunctions not listed in the table.

**Table 9-1:** Troubleshooting

Malfunction	Possible reasons	Recommended action
Actuator stem does not move.	Actuator is blocked.	→ Check attachment. → Remove the blockage.
	No or incorrect supply voltage connected.	→ Check the supply voltage and connections.
Actuator stem does not move through the whole range.	No or incorrect supply voltage connected.	→ Check the supply voltage and connections.
The actuator does not control the valve position.	The actuator was not initialized during start-up.	→ Check the switch position of the function and direction of action switches. → Initializing the actuator
	The mounting has been changed.	

## 9.1 Error indication by LEDs

### Blinking pattern of red LED

- Limit contact error

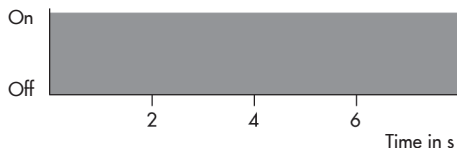

- Input signal failure

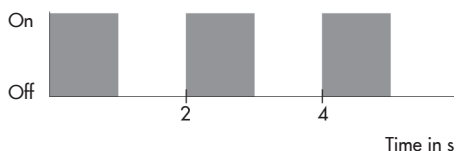

- EEPROM error

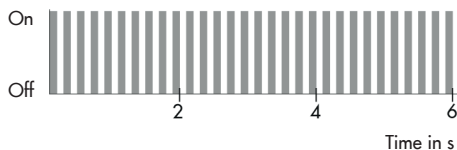

### Blinking pattern of yellow LED

- Plausibility error in memory pen

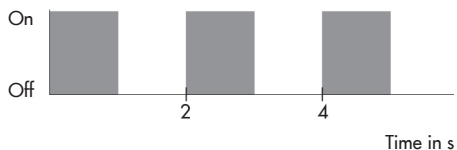

- EEPROM error in memory pen

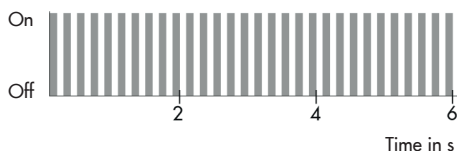



## 9.2 Emergency action

The valve, on which the actuator with fail-safe action is mounted, is moved to its fail-safe position upon failure of the supply voltage (see the 'Design and principle of operation' section). Plant operators are responsible for emergency action to be taken in the plant.

---



*Emergency action in the event of valve failure is described in the associated valve documentation.*

---



## 10 Servicing

The work described in this section is only to be performed by personnel appropriately qualified to carry out such tasks.

### **i** Note

*The electric actuator was checked by SAMSON before it left the factory.*

*– The product warranty becomes void if service or repair work not described in these instructions is performed without prior agreement by SAMSON's After-sales Service.*

The actuator requires no maintenance.

We recommend inspection and testing according to Table 10-1.

**Table 10-1:** *Recommended inspection and testing*

Inspection and testing	Action to be taken in the event of a negative result
Check the markings, labels and nameplates on the electric actuator for their readability and completeness.	→ Immediately renew damaged, missing or incorrect nameplates or labels.
	→ Clean any inscriptions that are covered with dirt and are illegible.
Check the electric wiring.	→ If any wires are loose, tighten the terminal screws (see the 'Installation' section).
	→ Renew damaged wires.



## 11 Decommissioning

The work described in this section is to be performed only by personnel appropriately qualified to carry out such tasks.

### **⚠ DANGER**

**Risk of fatal injury due to electric shock.**

- Before disconnecting live wires at the actuator, disconnect the supply voltage and protect it against unintentional reconnection.

### **⚠ WARNING**

**Risk of personal injury due to residual process medium in the valve.**

While working on the valve, residual medium can flow out of the valve and, depending on its properties, cause personal injury, e.g. (chemical) burns.

- Wear protective clothing, safety gloves and eye protection.

### **⚠ WARNING**

**Risk of burn injuries due to hot or cold components and pipeline.**

Valve components and the pipeline may become very hot or cold. Risk of burn injuries.

- Allow components and pipelines to cool down or warm up to the ambient temperature.
- Wear protective clothing and safety gloves.

To decommission the electric actuator for maintenance work or disassembly, proceed as follows:

- Put the control valve out of operation. See associated valve documentation.
- Disconnect the supply voltage and protect it against unintentional reconnection.
- Make sure that a signal from the controller cannot act upon the actuator.



## 12 Removal

The work described in this section is to be performed only by personnel appropriately qualified to carry out such tasks.

### **⚠ DANGER**

**Risk of fatal injury due to electric shock.**

→ Before disconnecting live wires at the actuator, disconnect the supply voltage and protect it against unintentional reconnection.

### **⚠ WARNING**

**Risk of personal injury due to hot components.**

→ If necessary, allow the pipeline and valve components to cool down.

### **⚠ WARNING**

**Risk of personal injury due to residual process medium.**

While working on the valve, residual medium can flow out of the valve and, depending on its properties, cause personal injury, e.g. (chemical) burns.

→ Wear protective clothing, safety gloves and eye protection.

## 12.1 Force-locking attachment

### Version without fail-safe action

1. Retract the actuator stem using the hand-wheel (see the 'Operation' section).
2. Open the front housing cover.
3. Disconnect and remove the wires of the connection cables from the terminals.
4. Unscrew the coupling nut (4 in Fig. 12-1) and remove the actuator from the valve connection.

### Version with "actuator stem extends" fail-safe action

1. Open the front housing cover.
  2. Disconnect and remove the wires of the connection cables from the terminals.
  3. Retract the actuator stem with a 4 mm Allen key (see the 'Operation' section).
- Hold the actuating shaft in place after retracting the actuator stem to prevent it from extending again.
4. Unscrew the coupling nut (4 in Fig. 12-1) and remove the actuator from the valve connection.

### Version with "actuator stem retracts" fail-safe action

- Proceed as for the version without fail-safe action.

## 12.2 Form-fit attachment

### Version without fail-safe action

1. Retract the actuator stem using the hand-wheel (see the 'Operation' section).

## Removal

2. Open the front housing cover.
3. Disconnect and remove the wires of the connection cables from the terminals.
4. Unfasten the stem connector clamps (12 in Fig. 12-1) between the actuator stem and the plug stem.
5. Undo the nut (13 in Fig. 12-1) and remove the rod-type yoke (11 in Fig. 12-1) together with the actuator from the valve.
6. Undo the coupling nut (4 in Fig. 12-1) and remove the actuator from the rod-type yoke (11 in Fig. 12-1).

### Version with "actuator stem extends" fail-safe action

1. Open the front housing cover.
  2. Disconnect and remove the wires of the connection cables from the terminals.
  3. Unfasten the stem connector clamps (12 in Fig. 12-1) between the actuator stem and the plug stem.
  4. Retract the actuator stem with a 4 mm Allen key (see the 'Operation' section).
- ➔ Hold the actuating shaft in place after retracting the actuator stem to prevent it from extending again.
5. Undo the nut (13 in Fig. 12-1) and remove the rod-type yoke (11 in Fig. 12-1) together with the actuator from the valve.
  6. Undo the coupling nut (4 in Fig. 12-1) and remove the actuator from the rod-type yoke (11 in Fig. 12-1).

### Version with "actuator stem retracts" fail-safe action

- ➔ Proceed as for the version without fail-safe action.



Force-locking attachment with coupling nut, e.g. to Type 3222 Valve

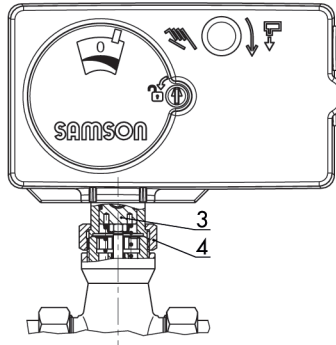

Form-fit attachment with stem connector, e.g. with yoke on Series V2001 Valve

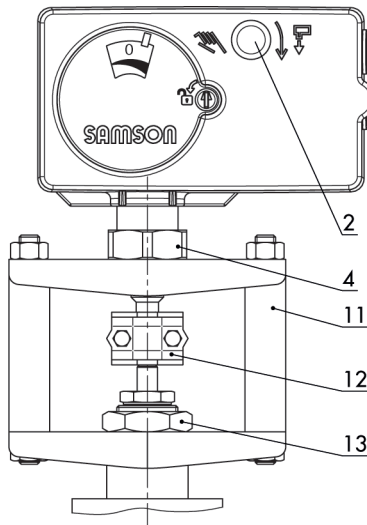

- 2 Handwheel
- 3 Actuator stem with actuator piston
- 4 Coupling nut
- 11 Yoke
- 12 Stem connector
- 13 Nut

Fig. 12-1: Mounting the actuator on the valve



## 13 Repairs

If the actuator does not function properly according to how it was originally configured or does not function at all, it is defective and must be exchanged.

---

**!** NOTICE

***Risk of actuator damage due to incorrect service or repair work.***

- Do not perform any repair work on your own.
  - Contact SAMSON's After-sales Service.
- 

### 13.1 Returning the actuator to SAMSON

Defective actuators can be returned to SAMSON for examination.

Proceed as follows to return devices:

1. Remove the electric actuator from the valve (see the 'Removal' section).
2. Continue as described on our website at
  - ▶ [www.samsongroup.com](http://www.samsongroup.com) > Service & Support > After-sales Service > Returning goods.



## 14 Disposal



SAMSON is a producer registered at the following European institution  
▶ <https://www.ewrn.org/national-registers/national-registers>.  
WEEE reg. no.:  
DE 62194439/FR 025665

- Observe local, national and international refuse regulations.
- Do not dispose of components, lubricants and hazardous substances together with your other household waste.

---

### **i** Note

*We can provide you with a recycling passport according to PAS 1049 on request. Simply e-mail us at [aftersaleservice@samsongroup.com](mailto:aftersaleservice@samsongroup.com) giving details of your company address.*

---

### Tip

*On request, we can appoint a service provider to dismantle and recycle the product as part of a distributor take-back scheme.*

---



## 15 Certificates

The following certificates are included on the next pages:

- EU declarations of conformity
- UKCA declaration of conformity
- TR CU certificate
- Declaration of incorporation

The certificates shown were up to date at the time of publishing. The latest certificates can be found on our website:

▶ [www.samsongroup.com](http://www.samsongroup.com) > Products & Applications > Product selector > Actuators > 5827

### 15.1 Information on the UK sales region

The following information corresponds to the Pressure Equipment (Safety) Regulations 2016, STATUTORY INSTRUMENTS, 2016 No. 1105 (UKCA marking). It does not apply to Northern Ireland.

#### Importer

SAMSON Controls Ltd  
Perrywood Business Park  
Honeycrook Lane  
Redhill, Surrey RH1 5JQ  
Tel.: +44 1737 766391

E-mail: ▶ [sales-uk@samsongroup.com](mailto:sales-uk@samsongroup.com)

Website: ▶ [uk.samsongroup.com](http://uk.samsongroup.com)

EU declarations of conformity



**EU Konformitätserklärung / EU Declaration of Conformity /  
Déclaration UE de conformité**

Die alleinige Verantwortung für die Ausstellung dieser Konformitätserklärung trägt der Hersteller/  
This declaration of conformity is issued under the sole responsibility of the manufacturer/  
La présente déclaration de conformité est établie sous la seule responsabilité du fabricant.

Für das folgenden Produkte / For the following product/ Nous certifions que les produit

**Elektrischer Antrieb / Electric Actuator / Servomoteur électrique  
Typ / Type / Type 5827**

wird die Konformität mit den einschlägigen Harmonisierungsrechtsvorschriften der Union bestätigt/  
the conformity with the relevant Union harmonisation legislation is declared with/  
sont conformes à la législation applicable harmonisée de l'Union:

EMC 2014/30/EU	EN 61000-6-2:2005, EN 61000-6-3:2007/A1:2011
LVD 2014/35/EU	EN 60730-1:2011 EN 60730-2-14 :1997/A1 :2005/A11 :2005/A2 :2008
RoHS 2011/65/EU	EN IEC 63000:2018

Hersteller / Manufacturer / Fabricant:

SAMSON AKTIENGESELLSCHAFT  
Weismüllerstraße 3  
D-60314 Frankfurt am Main  
Deutschland/Germany/Allemagne

Frankfurt / Francfort, 2023-01-10

Im Namen des Herstellers/ On behalf of the Manufacturer/ Au nom du fabricant.

  
Fabio Roma  
Vice President Smart Products & Components

  
Sebastian Krause  
Vice President Product Development



EU DECLARATION OF CONFORMITY  
TRANSLATION



**Declaration of Conformity of Final Machinery**

in accordance with Annex II, section 1.A. of the Directive 2006/42/EC

For the following product:

**Type 3222/XXXX-X Electric Control Valve consisting of Type 3222 Valve and 5857, 5824, 5825, 5827, TROVIS 5757-X, TROVIS 5724-X or TROVIS 5725-X Actuator**

We hereby declare that the machinery mentioned above complies with all applicable requirements stipulated in Machinery Directive 2006/42/EC.

For product descriptions refer to:

- Electric and Pneumatic Control Valves Type 3222/...:  
Mounting and Operating Instructions EB 5866

Referenced technical standards and/or specifications:

- VCI, VDMA, VGB: "Leitfaden Maschinenrichtlinie (2006/42/EG) – Bedeutung für Armaturen, Mai 2018" [German only]
- VCI, VDMA, VGB: "Zusatzdokument zum Leitfaden Maschinenrichtlinie (2006/42/EG) – Bedeutung für Armaturen vom Mai 2018" [German only], based on DIN EN ISO 12100:2011-03

Comment:

Information on residual risks of the machinery can be found in the mounting and operating instructions of the valve and actuator as well as in the referenced documents listed in the mounting and operating instructions.

Persons authorized to compile the technical file:

SAMSON AG, Weismüllerstraße 3, 60314 Frankfurt am Main, Germany  
Frankfurt am Main, 22 September 2023

Norbert Tollas  
Senior Vice President  
Global Operations

Peter Scheermesser  
Director  
Product Maintenance and Engineered Products

Revision no. 00

EU DECLARATION OF CONFORMITY  
TRANSLATION



**Declaration of Conformity of Final Machinery**

in accordance with Annex II, section 1.A. of the Directive 2006/42/EC

For the following product:

**Type 3214/XXXX-X Electric Control Valve consisting of Type 3214 Valve and TROVIS 5724-X, TROVIS 5725-X, Type 5824, Type 5825, Type 5827, Type 3274 or Type 3374 Actuator**

We hereby declare that the machinery mentioned above complies with all applicable requirements stipulated in Machinery Directive 2006/42/EC.

For product descriptions refer to:

- Type 3214/... Electric and Pneumatic Control Valves:  
Mounting and Operating Instructions EB 5868/5869

Referenced technical standards and/or specifications:

- VCI, VDMA, VGB: "Leitfaden Maschinenrichtlinie (2006/42/EG) – Bedeutung für Armaturen, Mai 2018" [German only]
- VCI, VDMA, VGB: "Zusatzdokument zum Leitfaden Maschinenrichtlinie (2006/42/EG) – Bedeutung für Armaturen vom Mai 2018" [German only], based on DIN EN ISO 12100:2011-03

Comment:

Information on residual risks of the machinery can be found in the mounting and operating instructions of the valve and actuator as well as in the referenced documents listed in the mounting and operating instructions.

Persons authorized to compile the technical file:

SAMSON AG, Weismüllerstraße 3, 60314 Frankfurt am Main, Germany  
Frankfurt am Main, 10 October 2023

Norbert Tollas  
Senior Vice President  
Global Operations

Peter Scheermesser  
Director  
Product Maintenance & Engineered Products

Revision no. 00

UKCA declaration of conformity

**UK  
CA** UK DECLARATION OF CONFORMITY  
ORIGINAL



This declaration of conformity is issued under the sole responsibility of the manufacturer.

For the following product:

**Electric Actuator Type 5827**

the conformity with the following relevant UK regulatory requirements is declared with:

UK Regulation / Statutory Instrument	Designated Standard
SI 2016 No. 1091 The Electromagnetic Compatibility Regulations 2016	EN 61000-6-2:2005 EN 61000-6-3:2007+A1:2011
SI 2016 No. 1101 The Electrical Equipment (Safety) Regulations 2016	EN 60730-1:2011 EN 61010-1:2010/A1:2019
SI 2012 No. 3032 The Restriction of the Use of Certain Hazardous Substances in Electrical and Electronic Equipment Regulations 2012	EN IEC 63000:2018

Manufacturer:

SAMSON AKTIENGESELLSCHAFT  
Weismuellerstrasse 3  
60314 Frankfurt am Main  
Germany

Frankfurt am Main, 2022-12-14

Signed for and behalf of the manufacturer:

  
Fabio Roma  
Vice President Smart Products & Components

  
Sebastian Krause  
Director Development Valves & Actuators

Revision 00

Classification: Public · SAMSON AKTIENGESELLSCHAFT · Weismuellerstrasse 3 · 60314 Frankfurt am Main, Germany Page 1 of 1

TR CU certificate

**ЕВРАЗИЙСКИЙ ЭКОНОМИЧЕСКИЙ СОЮЗ  
ДЕКЛАРАЦИЯ О СООТВЕТСТВИИ**



**Заявитель** Общество с ограниченной ответственностью "САМСОН КОНТРОЛС".

Основной государственный регистрационный номер: 1037700041026. Место нахождения и адрес места осуществления деятельности: 109544, город Москва, бульвар Энтузиастов, дом 2, этаж 5, комната 11, Российская Федерация. Телефон: +7 (495) 777-4545, адрес электронной почты: samson@samson.ru.

в лице Генерального директора Крымшамхалова Азрета Индрисовича, действующего на основании Устава.

заявляет, что Приводы электрические торговой марки SAMSON, типы: 5824, 5825, 5827.

Изготовитель "SAMSON AKTIENGESELLSCHAFT".

Место нахождения: Weismuellerstrasse 3, 60314 Frankfurt am Main, Федеративная Республика Германия. Адреса мест осуществления деятельности по изготовлению продукции: Weismuellerstrasse 3, 60314 Frankfurt am Main, ("SAMSON AKTIENGESELLSCHAFT"), Федеративная Республика Германия; ul. Spacerowa 30, 57-402 Nowa Ruda, ("Framo Morat Polska Sp. z o.o."), Польша.

Продукция изготавливается в соответствии со стандартами согласно приложению № 1.

Код ТН ВЭД ЕАЭС: 8501 10 930 0.

Серийный выпуск.

соответствует требованиям Технических регламентов Таможенного союза: "О безопасности низковольтного оборудования" (ТР ТС 004/2011), "Электромагнитная совместимость технических средств" (ТР ТС 020/2011).

Декларация о соответствии принята на основании эксплуатационной документации (руководства по эксплуатации 3428-ЭП-2021.РЭ, паспорта 3428-5824-30-2021.ПС); протокола № 1-06-2021 от 02.06.2021, выданного Испытательной лабораторией Общества с ограниченной ответственностью "НТЦ "ВОРОНЕЖ-ЭКСПЕРТ".

Схема декларирования соответствия: 1д.

Дополнительная информация ГОСТ 12.2.007.0-75 "Система стандартов безопасности труда. Изделия электротехнические. Общие требования безопасности"; ГОСТ 12.2.007.1-75 "Система стандартов безопасности труда. Машины электрические вращающиеся. Требования безопасности"; ГОСТ 30804.6.2-2013 раздел 8 " Совместимость технических средств электромагнитная. Устойчивость к электромагнитным помехам технических средств, применяемых в промышленных зонах. Требования и методы испытаний"; ГОСТ 30804.6.4-2013 раздел 7 " Совместимость технических средств электромагнитная. Электромагнитные помехи от технических средств, применяемых в промышленных зонах. Нормы и методы испытаний".

Условия хранения: в отопляемых хранилищах при температуре окружающего воздуха от минус 20 °С до плюс 70 °С и относительной влажности до 70%. Назначенный срок хранения: 24 месяца. Назначенный срок службы: 12 лет.

Декларация о соответствии действительна с даты регистрации

по 15.06.2026 включительно.

*(подпись)*



Крымшамхалов Азрет Индрисович

(Ф.И.О. заявителя)

Регистрационный номер декларации о соответствии:

ЕАЭС N RU Д-ДЕ.РА01.В.33473/21

Дата регистрации декларации о соответствии: 16.06.2021

**ЕВРАЗИЙСКИЙ ЭКОНОМИЧЕСКИЙ СОЮЗ**

**ПРИЛОЖЕНИЕ № 1  
К ДЕКЛАРАЦИИ О СООТВЕТСТВИИ ЕАЭС N RU Д-ДЕ.РА01.В.33473/21**

Лист № 1 из 1

**Наименования и реквизиты документов, в соответствии с которыми изготавливается продукция**

IEC 60730-1:2013 / Cor. 1:2014 "Automatic electrical controls for household and similar use. Part 1. General requirements. Corrigendum 1"	"Устройства управления автоматические электрические. Часть 1. Общие требования. Поправка 1"
EN 61000-6-1:2007 "Electromagnetic compatibility (EMC) - Part 6-1: Generic standards - Immunity for residential, commercial and light-industrial environments"	"Электромагнитная совместимость. Часть 6-1. Общие стандарты. Помехоустойчивость для жилых районов, районов с коммерческими предприятиями и районов с небольшими производственными предприятиями"
IEC 61000-6-2:2016 "Electromagnetic compatibility (EMC). Part 6-2: Generic standards. Immunity for industrial environments"	"Электромагнитная совместимость (ЭМС). Часть 6-2: Общие стандарты. Помехоустойчивость для промышленных сред"
EN 61000-6-3:2007 + A1:2011 "Electromagnetic compatibility (EMC). Part 6-3: Generic standards. Emission standard for residential, commercial and light-industrial environments"	"Электромагнитная совместимость (ЭМС). Часть 6-3: Общие стандарты. Стандарт излучения для жилых, коммерческих и легких промышленных сред"
IEC 61010-1:2010 "Safety requirements for electrical equipment for measurement, control, and laboratory use. Part 1: General requirements"	"Требования безопасности к электрическому оборудованию для измерения, контроля и лабораторного использования. Часть 1: Общие требования"
EN 61326-1:2013 "Electrical equipment for measurement, control and laboratory use. EMC requirements. Part 1: General requirements"	"Электрооборудование для измерения, контроля и лабораторного использования. Требования ЭМС. Часть 1: Общие требования"

  
(подпись)



Крымшамхалов Азрет Индрисович  
(Ф.И.О. заявителя)

Declaration of incorporation

DECLARATION OF INCORPORATION  
TRANSLATION



**Declaration of Incorporation in Compliance with Machinery Directive 2006/42/EC**

For the following product:  
**Type 5827 Actuator**

We certify that the Types 5824 and 5825 Electric Actuators are partly completed machinery as defined in the Machinery Directive 2006/42/EC and that the safety requirements stipulated in Annex I, 1.1.2, 1.1.3, 1.1.5, 1.2.1, 1.2.2, 1.2.3, 1.2.5, 1.2.6, 1.3.1, 1.3.2, 1.3.3, 1.3.4, 1.3.7, 1.3.8.2, 1.3.9, 1.4.1, 1.5.1, 1.5.3, 1.5.4 and 1.5.8 are observed. The relevant technical documentation described in Annex VII, part B has been compiled.

Products we supply must not be put into service until the final machinery into which it is to be incorporated has been declared in conformity with the provisions of the Machinery Directive 2006/42/EC.

Operators are obliged to install the products observing the accepted industry codes and practices (good engineering practice) as well as the mounting and operating instructions. Operators must take appropriate precautions to prevent hazards that could be caused by the process medium and operating pressure in the valve as well as by the signal pressure and moving parts.

The permissible limits of application and mounting instructions for the products are specified in the associated mounting and operating instructions; the documents are available in electronic form on the Internet at [www.samsongroup.com](http://www.samsongroup.com).

For product descriptions refer to:

- Type 5827 Electric Actuator: Mounting and Operating Instructions EB 5827-1 / EB 5827-2

Referenced technical standards and/or specifications:

- VCI, VDMA, VGB: "Leitfaden Maschinenrichtlinie (2006/42/EG) – Bedeutung für Armaturen, Mai 2018" [German only]
- VCI, VDMA, VGB: "Zusatzdokument zum Leitfaden Maschinenrichtlinie (2006/42/EG) – Bedeutung für Armaturen vom Mai 2018" [German only], based on DIN EN ISO 12100:2011-03

Comments:

- See mounting and operating instructions for residual hazards.
- Also observe the referenced documents listed in the mounting and operating instructions.

Persons authorized to compile the technical file:

SAMSON AG, Weismüllerstraße 3, 60314 Frankfurt am Main, Germany  
Frankfurt am Main, 21 February 2021

Stephan Giesen  
Director  
Product Management

Sebastian Krause  
Director  
Strategic R&D, Valves and Actuators

Revision no. 02

## 16 Annex A (Configuration and Operating Instructions)

### **i** Note

The actuator is configured with the TROVIS-VIEW software (► EB 6661).

## 16.1 Location of switches and LEDs

### **i** Note

The location of the direction of action switch, function switch and LEDs of the current 24 V version of this actuator are shown in sections 6 and 7. The images and descriptions that apply to previous versions of the actuator are included in this section.

### **!** NOTICE

**Specified degree of protection does not apply when the housing cover is open.**

→ Ensure that no moisture or foreign particles can get into the actuator.

### 16.1.1 LEDs

#### LEDs under the front housing cover (24 V version)

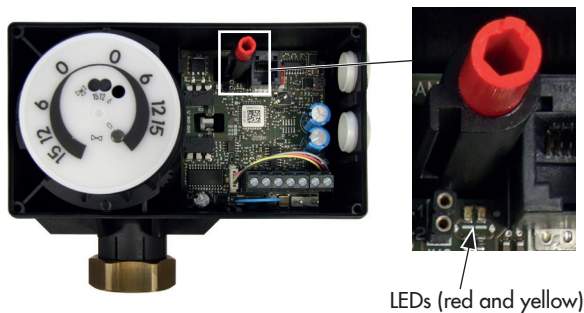

Fig. 16-2: Location of LEDs in 24 V version

## 16.1.2 Function switch

- **Switch position A (default):**
  - Input signal 0 to 10 V or 0 to 20 mA
  - Input signal settings in TROVIS-VIEW **are taken into account.**
- **Switch position B:**
  - Input signal 2 to 10 V or 4 to 20 mA
  - Input signal settings in TROVIS-VIEW **are ignored.**

Function switch (24 V version)

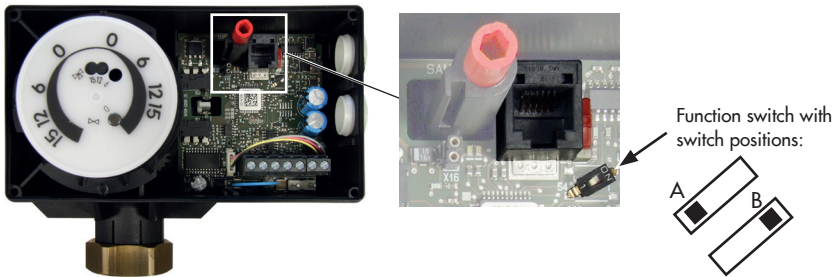

Fig. 16-3: Function switch (24 V version)



### 16.1.3 Direction of action switch

- **Switch position A (default):** direction of action increasing/increasing (>>)
- The actuator stem retracts as the input signal increases.
- **Switch position B:** direction of action increasing/decreasing (<<)
- The actuator stem extends as the input signal increases.

#### Direction of action switch (24 V version)

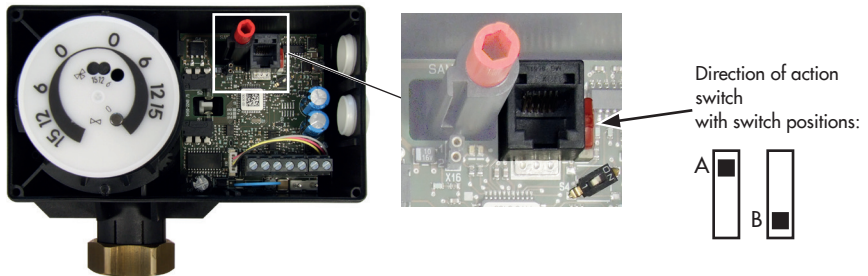

Fig. 16-4: Direction of action switch (24 V version)

### 16.2 Input signal

The input signal determines the actuator stem position. A voltage or current signal can be used as the input signal.

The default lower and upper range values of the input signal are 0 to 10 V or 0 to 20 mA.

#### **i** Note

*At least 2.5 V or 5 mA (depending on the input signal used) must separate the upper and lower range values.*

➔ Click 'Settings' folder ('Inputs and outputs').

The settings for the input and output signal are shown:

Settings\Inputs and outputs\Input signal

Input signal	WE	Adjustment range
Lower range value	0.0 V or 0.0 mA	0.0 to 7.5 V or 0.0 to 15.0 mA
Upper range value	10.0 V or 20.0 mA	2.5 to 10.0 V or 5.0 to 20.0 mA

#### 16.2.1 Split-range operation

The input signal range can be adapted, e.g. to achieve a plant operation characteristic by connecting two or more actuators in parallel (split-range operation).

Example: Two valves regulate the process medium in one common pipeline to achieve a large rangeability. One valve opens with a 0 to 5 V input signal, while the second valve also opens when the input signal increases further (5 to 10 V) and the first valve remains open. The two valves close in the reverse order.

### 16.3 Position feedback signal

The position feedback indicates the position of the actuator stem.

The span of the position feedback signal is adjusted over the lower and upper range value parameters.

Settings\Inputs and outputs\Position feedback signal

Position feedback signal	WE	Adjustment range
Lower range value	0.0 V	0.0 V to 10.0 V
Upper range value	10.0 V	0.0 V to 10.0 V

## 16.4 Functions

### 16.4.1 Detect input signal failure

The positioner detects a failure of the input signal as soon as the value falls below the lower range value by 0.3 V or 0.6 mA. An input signal failure is indicated in the 'Service' folder ('Errors') as well as by the **red LED**:

#### **i** Note

*The input signal failure can only be detected when at least 0.5 V or 1 mA is set as the lower range value.*

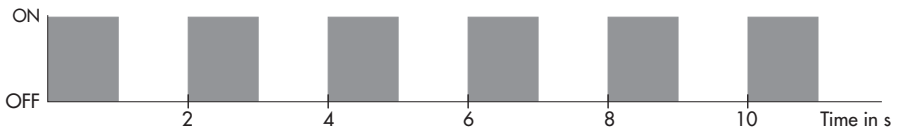

If the 'Detect input signal failure' function is active, the reaction of the actuator upon failure of the input signal is determined by the **Positioning value upon input signal failure** parameter.

- 'Positioning value upon input signal failure' = **Internal**  
The actuator stem moves to the position specified in the 'Internal positioning value' parameter upon failure of the input signal.
- 'Positioning value upon input signal failure' = **Last position**  
The actuator stem remains in the last position that the valve moved to before failure of the input signal.

The error message is reset and the actuator returns to closed-loop operation if the input signal moves within 0.2 V or 0.4 mA of the lower range value.

Settings \ Actuator \ Functions

Functions	WE	Adjustment range
Detect input signal failure	No	Yes/No
Positioning value upon input signal failure	Internal	Internal, last position
Internal positioning value	0.0 %	0.0 to 100.0 %

## 16.4.2 End position guiding

The actuator stem moves to the end position earlier if the end position guiding function is active.

- 'Value below limit (end position guiding)'  
The actuator stem moves to the 0 % position when the input signal falls below 'Value below limit (end position guiding)'.
- 'Value above limit (end position guiding)'  
The actuator stem moves to the 100 % position when the input signal falls below 'Value above limit (end position guiding)'.

### **i** Note

When 'Value below limit (end position guiding)' = 0 % and 'Value above limit (end position guiding)' = 100 %, the end position guiding function is deactivated.

Settings\Actuator\Functions

Functions	WE	Adjustment range
End position guiding when the value falls below the limit	1.0 %	0.0 to 49.9 %
Value above limit (end position guiding)	97.0 %	50.0 to 100.0 %

## 16.5 Blockage

### 16.5.1 Blocking protection

The blocking protection prevents the valve from seizing up. If the actuator stem is in the lower end position (0 %), it is extended slightly and then moved back to the closed position 24 hours after it last moved.

Movement of the actuator stem caused by the activated blocking protection is indicated by the **yellow LED**:

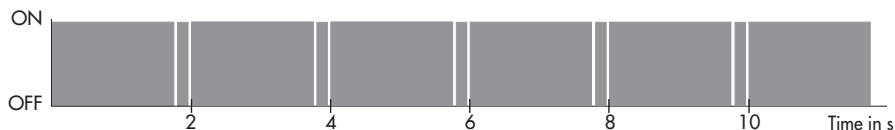

Settings\Actuator\Blockage

Function	WE	Adjustment range
Blocking protection	No	Yes/No

## 16.6 Travel

### 16.6.1 Limited travel range

The 'limited travel range' parameter determines in % how far the actuator stem can move at the maximum. The travel determined during initialization acts as the reference.

Settings\Actuator\Travel

Function	WE	Adjustment range
Limited travel range	100.0 %	30.0 to 100.0 %

### 16.6.2 Travel adjustment

Travel adjustment can be made to be absolute or relative. The way the travel adjustment is made affects the control behavior.

- **Absolute travel adjustment:**  
The absolute travel adjustment causes the actuator stem to move to the actuator stem position determined by the input signal. To achieve this, an automatic zero calibration is performed after every start-up to obtain a reference value for the zero point. The position feedback indicates the position of the actuator stem.
- **Relative travel adjustment**  
The relative travel adjustment causes the change in input signal to be reproduced by the position of the actuator stem. The actuator stem extends or retracts from the current actuator stem position corresponding to the change in signal. After starting up the actuator, a zero calibration is not performed. The stem position is unknown when starting operation. The input signal is assigned in this case as the start value. The position feedback indicates the actuator stem position in relation to the start value.

Settings\Actuator\Travel

Function	WE	Adjustment range
Travel adjustment	Absolute	Absolute/Relative



### Tip

*In closed-loop operation, the positioner must be operated with absolute travel adjustment (default setting).*

---

### 16.6.3 Idle time during end position guiding

The idle time for **relative travel adjustment** paces the gradual movement of the actuator stem towards the end position.

With the relative stem position, the input signal can preset a value of 0 % or 100 %. However, the actuator stem can only be moved to its upper range value. The input signal cannot move the actuator stem beyond this position. The actuator stem is moved towards the end position in steps with the hysteresis. The idle time defines the time between the steps. The paced stem movement is deactivated when the value is set to 0.

Settings\Actuator\Functions

Function	WE	Adjustment range
Idle time during end position guiding	0 s	0 to 99 s



### Note

*The further description refers to the operation with absolute travel adjustment, unless specified otherwise.*

---

### 16.6.4 Speed

The actuator stem moves to the position determined by the input signal at the selected stroking speed. There are three speed levels:

- Slow = 0.135 mm/s
- Standard = 0.197 mm/s
- Fast = 0.365 mm/s

Settings\Actuator\Travel

Function	WE	Adjustment range
Speed	Standard	Slow, Standard, Fast

**i Note**

The transit time is calculated from the travel and the stroking speed. The transit time is the time that the actuator stem needs to move through the adjusted travel.

The following applies:  $\text{Transit time in s} = \frac{\text{Travel in mm}}{\text{Stroking speed in mm/s}}$

### 16.6.5 Dead band (switching range)

The dead band determines how sensitive the actuator reacts. A change in the input signal by the hysteresis first causes a minimally small change in the valve position.

Settings\Actuator\Travel

Function	WE	Adjustment range
Dead band (switching range)	2.0 %	0.5 to 5.0 %

### 16.6.6 Characteristic

The characteristic expresses the relation between the input signal and the actuator stem position.

Perform the characteristic settings in the Settings folder (Actuator\Characteristic):

### Characteristic types

– **Linear**

The travel is proportional to the input signal.

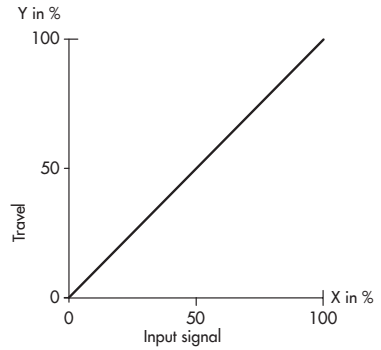

– **Equal percentage**

The travel is exponential to the input signal.

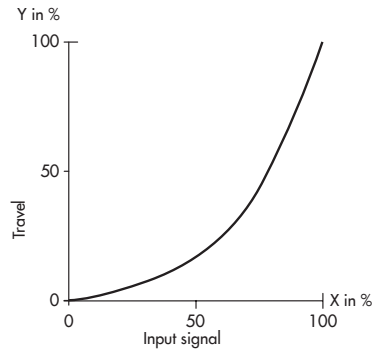

– **Reverse equal percentage**

The travel is reverse exponential to the input signal.

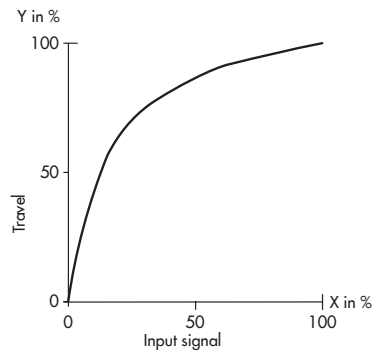

– **User-defined**

A new characteristic based on the characteristic set can be defined over eleven points.



## 16.6.7 Start-up

Initialization can be started in the 'Service' folder ('Start-up').

## 16.6.8 Functions ('Service' folder)

The following functions can be performed in the 'Service' folder ('Functions'):

### 16.6.8.1 Manual level

The actuator can be switched to the manual mode using the TROVIS-VIEW software if the manual level is enabled in online mode. The actuator leaves the manual mode as soon as you exit the manual level or the online mode in TROVIS-VIEW.

The following actions can be activated in the manual level:

- Retract actuator stem
- Extend actuator stem
- Move stem to standardized value
- ➔ First enter the required positioning value in relation to the input signal range (standardized positioning value).
- Issue standardized position feedback
- ➔ First enter the required position feedback in relation to the span of the position feedback signal (standardized position feedback).
- Issue error message
- Activate the yellow LED
- Activate the red LED

## 16.6.8.2 Functions

### **Perform reset**

The actuator is restarted.

### **Load default settings in actuator**

The configuration is reset to the default setting.

### **Start zero calibration**



The actuator moves to the lower end position (stem extended). After the zero calibration is completed, the transit time is adopted and the actuator is ready for operation. The actuator stem is moved to the position determined by the input signal.

### **Start transit time measurement**

Measures the time required to move from one end position to the other.

## 17 Annex B

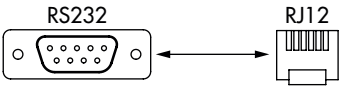
### 17.1 Accessories

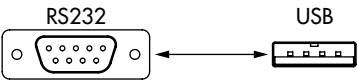
Accessories	
Hardware package consisting of: <ul style="list-style-type: none"> <li>- Memory pen-64</li> <li>- Connecting cable</li> <li>- Modular adapter</li> </ul>	Order no. 1400-9998
Memory pen-64	Order no. 1400-9753 
Connecting cable	Order no. 1400-7699 
Modular adapter	Order no. 1400-7698 
USB to RS232 adapter	Order no. 8812-2001 
Software	
TROVIS-VIEW (free of charge)	▶ <a href="http://www.samsung.com">www.samsung.com</a> > Service & Support > Downloads > TROVIS-VIEW

Accessories	
Cable gland <sup>1)</sup>	
M16x1.5 cable gland with 14x1.5 O-ring for 5 to 10 mm clamping range	Order no. 8808-1010
M16x1.5 cable gland for 4 to 8 mm clamping range	Order no. 100161061
O-ring 14x1.5	Order no. 8421-0070
M16x1.5 lock nut with width AF 19	Order no. 8808-1032
<sup>1)</sup> It is not possible to use the cable glands from the Types 5824 and 5825 Actuators.	
For mounting on form-fit valves	
Rod-type yoke	Order no. 1400-7414
Spacer to mount the actuator on Type 3323 Valve (DN 65 to 80)	Order no. 0340-3031

## 17.2 After-sales service

Contact our after-sales service for support concerning service or repair work or when malfunctions or defects arise.

### E-mail contact

You can reach our after-sales service at ► [aftersalesservice@samsongroup.com](mailto:aftersalesservice@samsongroup.com).

### Addresses of SAMSON AG and its subsidiaries

The addresses of SAMSON, its subsidiaries, representatives and service facilities worldwide can be found on our website (► [www.samsongroup.com](http://www.samsongroup.com)) or in all SAMSON product catalogs.

### Required specifications

Please submit the following details:

- Type designation
- Material number
- Serial number
- Firmware version

## 17.3 Configuration list and customer-specific data

Configuration	Default setting	Adjustment range	Setting
<b>Input signal</b>			
Lower range value	0.0 V 0.0 mA	0.0 to 7.5 V 0.0 to 15.0 mA	
Upper range value	10.0 V 20.0 mA	2.5 to 10.0 V 5.0 to 20.0 mA	
Unit	V	V/mA	
<b>Position feedback signal</b>			
Lower range value	0.0 V	0.0 to 10.0 V	
Upper range value	10.0 V	0.0 to 10.0 V	
<b>Functions</b>			
Detect input signal failure	No	Yes/No	
Positioning value upon input signal failure	Internal positioning value	Internal positioning value/last travel value	
Internal positioning value	0.0 %	0.0 to 100.0 %	
Value below limit (end position guiding)	1.0 %	0.0 to 49.9 %	
Value above limit (end position guiding)	97.0 %	50.0 to 100.0 %	
Blocking protection	No	Yes/No	
Limited travel range	100.0 %	30.0 to 100.0 %	
Travel adjustment	Absolute	Absolute/Relative	
Speed	Standard	Slow/Standard/Fast	
Dead band (switching range)	2.0 %	0.5 to 5.0 %	
Characteristic type	Linear	Linear Equal percentage Reverse equal percentage User-defined	





**EB 5827-2 EN**



SAMSON AKTIENGESELLSCHAFT  
Weismüllerstraße 3 · 60314 Frankfurt am Main, Germany  
Phone: +49 69 4009-0 · Fax: +49 69 4009-1507  
samson@samsongroup.com · www.samsongroup.com